



## Crompton Instruments Protector Trip Relays



# Protector Trip Relays

An extensive range of electronic control products providing continuous monitoring and protection of any electrical parameter. When the monitored parameter deviates from the desired set trip limit, the relay will operate to prevent damage to power asset. This versatile range features a host of stylish DIN-rail protectors offering numerous trip functions for single and three-phase power systems, including over and under voltage, current, frequency, phase sequence/failure or balance, reverse power, synchro-check, speed sensing and finally DC inputs.



Contents	Page
■ <b>AC Current</b>	<b>2 - 5</b>
■ <b>AC Voltage</b>	<b>6 - 11</b>
■ <b>Frequency</b>	<b>12 - 13</b>
■ <b>Phase Sequence and Phase Failure</b>	<b>14 - 15</b>
■ <b>Phase Balance, Sequence and Voltage Monitor</b>	<b>16 - 17</b>
■ <b>Synchro-check (Paralleling)</b>	<b>18 - 19</b>
■ <b>Reverse Power (Current)</b>	<b>20 - 21</b>
■ <b>DC Millivolts and Transducer</b>	<b>22 - 23</b>
■ <b>Thermistor</b>	<b>24 - 25</b>
■ <b>Speed Sensing</b>	<b>26 - 27</b>
■ <b>373-ELR Earth Leakage Protection Relay</b>	<b>28 - 29</b>
■ <b>CBT-94F Core Balanced Current Transformers</b>	<b>30</b>
■ <b>373-GFR Ground Fault Relay</b>	<b>31 - 32</b>
■ <b>Part Numbers</b>	<b>33</b>

## Features

- LED fault indication
- Adjustable nominal voltages, trip points, time delay and differentials
- Compact DIN-rail enclosure
- Power on LED (Green)
- Designed to avoid nuisance tripping

## Benefits

- Protection of power assets
- Detection and isolation of faults
- Maintains supply continuity of healthy circuits
- High speed tripping to avoid damage

## Application

- Switchgear
- Distribution systems
- Process control
- Motor protection
- Equipment and network protection



## AC Current

AC current protectors provide a continuous surveillance of monitored circuits and offer user adjustable trip points (set points) with time delay settings. When the current moves outside the set point limit for longer than the time delay, the relay will operate providing an alarm control or tripping signal.

### Basic Parameters

- Universal auxiliary supply 24-240V AC/DC galvanically isolated from monitored current circuit
- Pre-set differential (hysteresis) 1%
- Trip level adjustment between 40-120% (In)
- Available with 1A or 5A nominal inputs of (In)
- Power on LED (green)

### Under Current - PAU

- Single-phase
- Continuously monitors to provide under current protection (set level I<sub>min</sub>)
- Adjustable time delay
- 1 module version

### Over Current - PAO

- Single-phase
- Continuously monitors to provide over current protection (set level I<sub>max</sub>)
- Adjustable time delay
- 1 module version

### Under and Over Current - PAD

- Single-phase
- Monitors decrease of current under a set level I<sub>min</sub> and simultaneously an over range of current above a set level I<sub>max</sub>
- Independently adjustable delay on both over and under set points
- Two output relays
- Three module version

### Under or Over Current - PAP/V

- Three-phase, three/four-wire
- Continuously monitors to provide under or over protection (set level In)
- Monitors three-phase current
- Selectable under or over protection
- Six module version

Part no.	1-phase	3-phase 3/4-wire	Protection
PAU	x		Under current
PAO	x		Over current
PAD	x		Under and over current
PAP/V		x	Under or over current



# AC Current

## Operation

The set point adjustment range is between 40% and 120% of the nominal current with 1A or 5A nominal input current (via current transformers or direct connection). An internal differential setting of 1% reduces nuisance tripping if the measured signal is noisy or unstable. Relay will trip if the measured current moves outside the set point limit and the red LED indicates a fault condition. An adjustable time delay eliminates premature operation on short duration current fluctuations. During this delay period the red LED will flash. Protectors draw their operating power from a separate auxiliary supply input.

## Under Current - PAU

Should the monitored current fall below the set point level  $I_{min}$ , the protector will trip and the red LED will illuminate indicating the fault condition. During the time delay period the red LED will flash for the set time ( $t$ ) before the relay de-energises output relay contacts. The relay will automatically reset once the monitored current rises above the set point level  $I_{min}$  plus the differential (internally pre-set 1%) causing the red LED to extinguish and the relay to make without time delay.

## Over Current - PAO

Should the monitored current exceed the set point level  $I_{max}$ , the protector will trip and the red LED will illuminate indicating the fault condition. During the time delay period the red LED will flash for the set time ( $t$ ) before the relay energises output relay contacts. The protector will automatically reset once the monitored current falls below the set point level  $I_{max}$  plus the differential (internally pre-set 1%) causing the red LED to extinguish and the relay to release without time delay.

## Under and Over Current - PAD

- PAD is a combination of both PAU and PAO products.

## Under or Over Current - PAP/V

The manner of operation depends on the mode selected at the front panel either Under Current or Over Current.

**Note: Red LED indicates fault condition, not relay status.**

## Characteristics

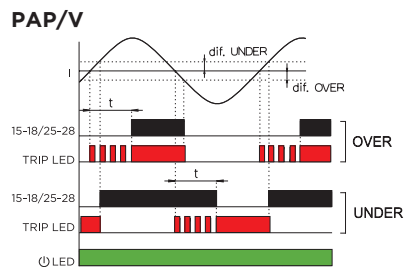
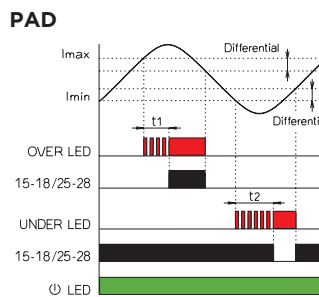
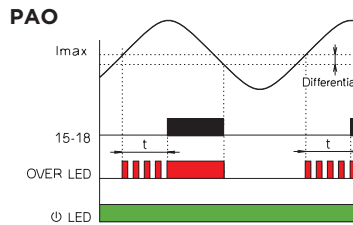
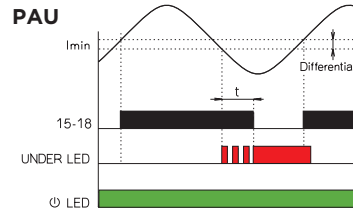

## Protector Overview

### PAU, PAO

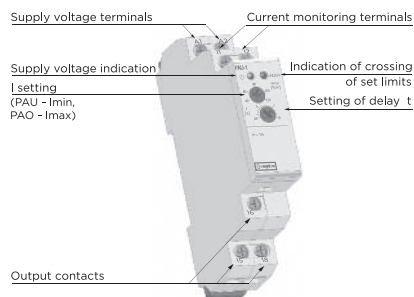

### PAP/V

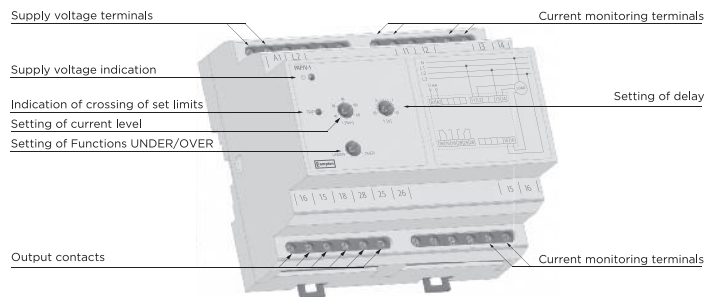

### PAD

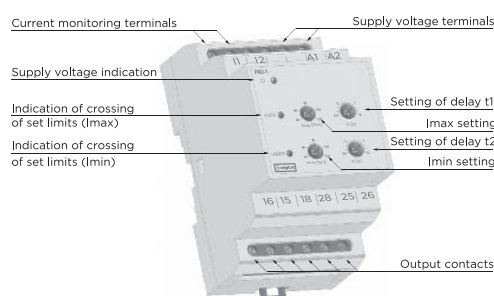

# AC Current

## Single-phase

Technical parameters	PAU-1	PAU-5	PAO-1	PAO-5	PAD-1	PAD-5
Under current protection (de-energise on trip)	•	•			•	•
Over current protection (energise on trip)			•	•	•	•
Auxiliary supply terminals	A1, A2					
Auxiliary supply voltage	24-240V AC/DC					
Auxiliary supply voltage tolerance	±10%					
Auxiliary voltage burden (max)	2.6VA/0.8W			3VA/1.2W		
Operating frequency AC	45-65 Hz					
Current input terminals	I1, I2					
Rated current In	1A AC	5A AC	1A AC	5A AC	1A AC	5A AC
Current input burden (max)	0.1VA	0.5VA	0.1VA	0.5VA	0.1VA	0.5VA
Upper current limit Imax	Adjustable 40-120% In					
Lower current limit Imin	Adjustable 40-120% In					
Overload capacity						
-continuous	2A	10A	2A	10A	2A	10A
-max. 3s	20A	50A	20A	50A	20A	50A
Differential (hysteresis)	Internally pre-set at 1% In					
Time delay	Adjustable 0.5-10s				Independently adjustable under/over 0.5-10s	
Output relay-contact	1x change over (AgNi) plated				2x change over (AgNi) plated	
Output relay-contact terminals	15, 16, 18				Under 15, 16, 18/over 25, 26, 28	
Load capability of relay contact AC	250V/8A, max. 2000VA					
Load capability of relay contact DC	30V/8A					
Mechanical life	3x10 <sup>6</sup> by rated load					
Relay reset	Automatic					
ANSI no.	37	37	50	50	37/50	37/50
Operating temperature	-20 +55°C					
Storage temperature	-30 +70°C					
Electric strength (supplying - contact relay)	4kV/1min.					
Overvoltage category	III.					
Pollution degree	2					
Enclosure integrity	IP40 from the front panel /IP10 terminals				IP40 from the front panel /IP20 terminals	
Enclosure style	DIN-rail, 1 module				DIN-rail, 3 module	
Case material	Flame retardant polycarbonate					
Connecting conductors profile (mm <sup>2</sup> )	max. 2x2.5mm <sup>2</sup> /1x4mm <sup>2</sup>				max. 2x1.5mm <sup>2</sup> /1x2.5mm <sup>2</sup>	
Dimensions	90x17.6x64mm				90x52x65mm	
Weight	70g	70g	70g	70g	208g	208g
Standards	EN 60255-6, EN 60255-27, EN 61000-6-2, EN 6100-6-4					

## Connection

### PAU, PAO

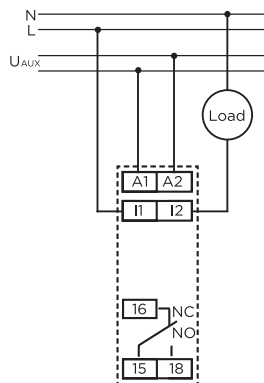

### PAD

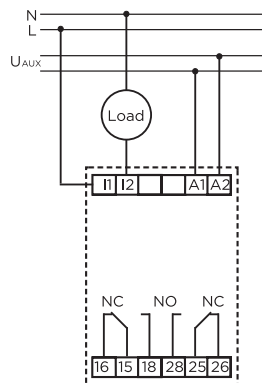

# AC Current

## Three-phase three/four-wire

Technical parameters	PAP/V-1	PAP/V-5
Under current protection (de-energise on trip)	Selectable	Selectable
Over current protection (energise on trip)	Selectable	Selectable
System type	3-phase (3~)	3-phase (3~)
Auxiliary supply terminals	A1, A2	
Auxiliary supply voltage	24-240V AC/DC	
Auxiliary supply voltage tolerance	±10%	
Auxiliary voltage burden (max)	3VA/1.2W	
Operating frequency AC	45-65 Hz	
Current input terminals		
L1 phase	11, 12	
L2 phase	13, 14	
L3 phase	15, 16	
Rated current In	1A DC	5A AC
Current input burden (max)	0.1VA	0.5VA
Upper current limit I <sub>max</sub>	Adjustable 40-120% I <sub>n</sub>	
Lower current limit I <sub>min</sub>	Adjustable 40-120% I <sub>n</sub>	
Overload capacity		
-continuous	2A	10A
-max. 3s	20A	50A
Differential (hysteresis)	Internally pre-set at 1% I <sub>n</sub>	
Time delay	Adjustable 0.5-10s	
Output relay-contact	2x change over (AgNi) plated	
Output relay-contact terminals	15, 16, 18 & 25, 26, 28	
Load capability of relay contact AC	250V/8A, max. 2000VA	
Load capability of relay contact DC	30V/8A	
Mechanical life	3x10 <sup>6</sup> by rated load	
Relay reset	Automatic	
ANSI no.	37/50	37/50
Operating temperature	-20 +55°C	
Storage temperature	-30 +70°C	
Electric strength (supplying -contact relay)	4kV/1min.	
Over voltage category	III.	
Pollution degree	2	
Enclosure integrity	IP40 from the front panel/IP20 terminals	
Enclosure style	DIN-rail, 6 module	
Case material	Flame retardant polycarbonate	
Connecting conductors profile (mm <sup>2</sup> )	max. 2x1.5mm <sup>2</sup> /1x2.5mm <sup>2</sup>	
Dimensions	90x105x64mm	
Weight	208g	208g
Standards	EN 60255-6, EN 60255-27, EN 61000-6-2, EN 6100-6-4	

## Connection

### PAP/V

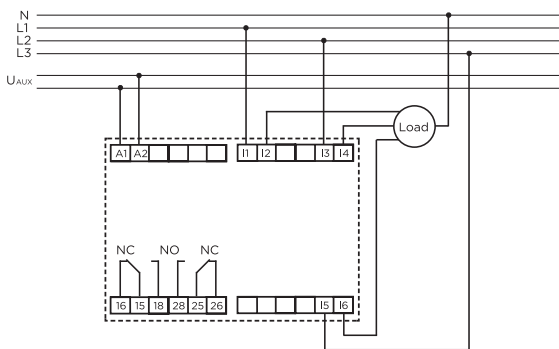

## AC Voltage

When the measured voltages moves outside the set point limit for longer than the time delay, the relay will operate giving an alarm control or tripping signal. The Protector can be used for under and over voltage detection, start standby generators, operation of mains failure units and switching standby suppliers. An illuminated Red LED indicates a fault condition. The three-phase, three or four-wire models with protect each phase independently.

### Basic Parameters

- Available with three voltage ranges 100-120V, 173-240V & 380-480V ( $U_n$ )
- Trip level adjustment between 75-100% ( $U_n$ ) Under
- Trip level adjustment between 100-125% ( $U_n$ ) Over
- Non-phase sequence sensitive
- Adjustable differential (hysteresis) 1-15%
- Adjustable time delay 0.5-10s ( $t$ )
- Power on LED (Green)

### Under Voltage

- Continuously monitors to provide under voltage protection (set level  $U_{min}$ )
- One and three module versions

Part no.	1-phase	3-phase 3-wire	3-phase 4-wire
PVU/Z	x		
PVK/J		x	
PVV/X			x

### Over Voltage

- Continuously monitors to provide over voltage protection (set level  $U_{max}$ )
- One and three module versions

Part no.	1-phase	3-phase 3-wire	3-phase 4-wire
PVO/H	x		
PVA/C		x	
PVP/S			x

### Under and Over Voltage

- Continuously monitors to provide under and over protection (set level  $U_{min}$  and  $U_{max}$ )
- Two output relays
- Three module version

Part no.	1-phase	3-phase 3-wire	3-phase 4-wire
PVB	x		
PVM		x	
PVE			x



# AC Voltage

## Operation

The set point adjustment range is 25%, operating between 75% and 100% of the nominal supply for under voltage and between 100% and 125% for the over voltage.

The adjustable differential setting range is 1% to 15% and can be used to reduce nuisance tripping if the measured signal is noisy or unstable. In case the measured voltage moves outside the set point limit the protector trips, illuminating the red LED indicating a fault condition.

An adjustable time delay is provided to eliminate premature operation on short duration voltage fluctuations. During this delay period the red LED will flash. The protectors draw their operating power from the measured inputs. Three-phase products monitor the voltage level for each phase and are not phase sequence sensitive.

### Under Voltage - PVU/Z, PVK/J, PVV/X

Should the monitored voltage fall below the set point level  $U_{min}$ , the protector will trip and the red LED will illuminate to indicate the fault condition. During the time delay period the red LED will flash for the set time ( $t$ ) before the relay deenergises. The protector will automatically reset once the monitored voltage rises above the set point level  $U_{min}$  plus the differential (between 1-15%) causing the red LED to extinguish and the relay to make without time delay. Should the voltage fall below the value of opening level  $U_{off}$  the protector under red LED will flash indicating a status of low nominal voltage causing the relay contact to return to original status.

### Over Voltage - PVO/H, PVA/C, PVP/S

Should the monitored voltage exceed the set point level  $U_{max}$ , the protector will trip and the red LED will illuminate to indicate the fault condition. During the time delay period the red LED will flash for the set time ' $t$ ' before the relay energises. The protector will automatically reset once the monitored voltage falls below the set point level  $U_{max}$  plus the differential (between 1-15%) causing the red LED to extinguish and the relay to release without time delay. Should the voltage fall below the value of opening level  $U_{off}$  the protector over red LED will flash indicating a status of low nominal voltage causing the relay contact to return to original status.

### Under and Over Voltage - PVB, PVM, PVE

- PVB is a combination of both PVU/Z and PVO/H products
- PVM is a combination of both PVK/J and PVA/C products
- PVE is a combination of both PVV/X and PVP/S products

**Note: Red LED indicates fault condition, not relay status.**

## Characteristics

### PVU/Z

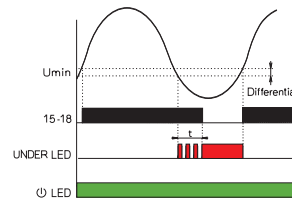

### PVK/J, PVV/X

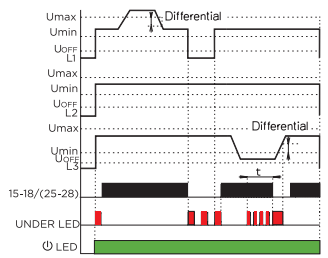

### PVO/H

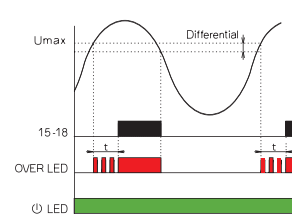

### PVA/C, PVP/S

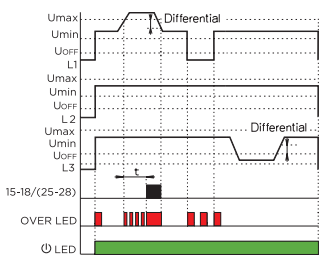

### PVB

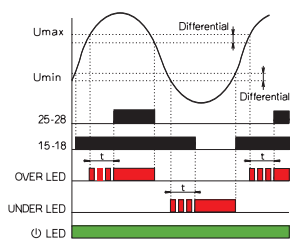

### PVM, PVE

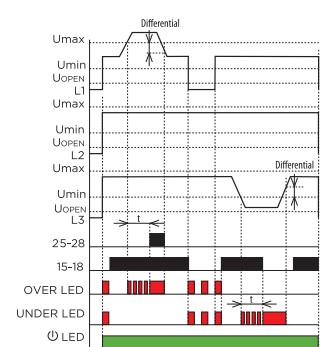

# AC Voltage

## Protector Overview

### Single-phase PVU/Z, PVO/H

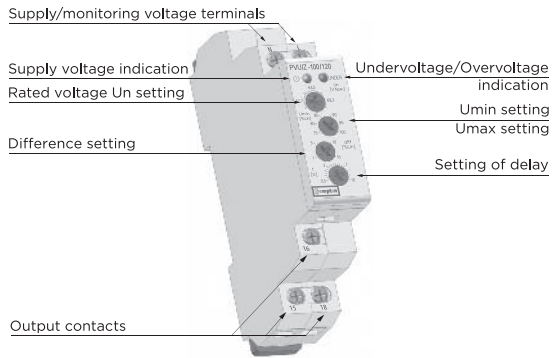

### PVB

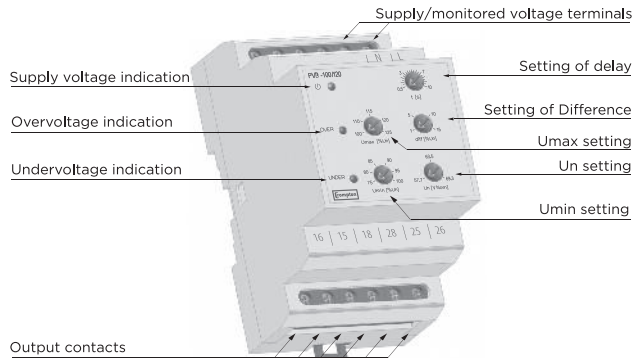

### Three-phase three-wire PVK/J, PVA/C (100/120, 173/240)

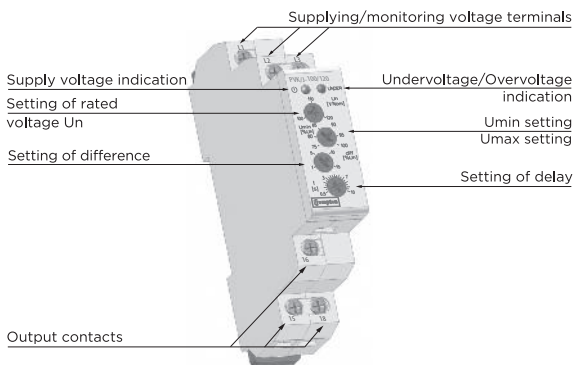

### PVM (100/120, 173/240, 380/480) PVK/J, PVA/C (380/480)

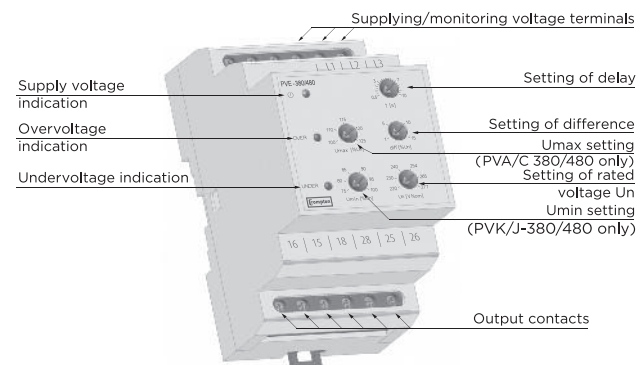

### Three-phase four-wire PVV/X, PVP/S (100/120, 173/240)

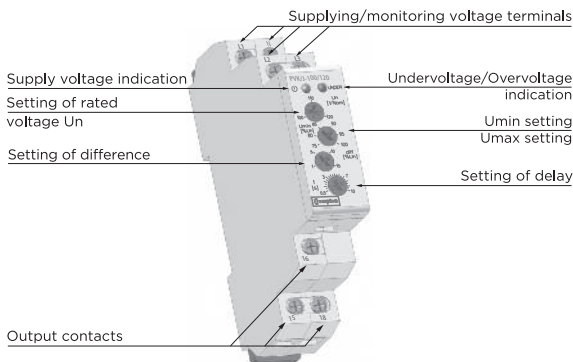

### PVE (100/120, 173/240, 380/480) PVV/X, PVP/S (380/480)

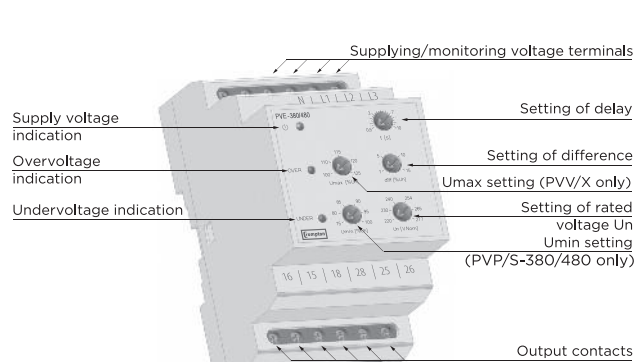

# AC Voltage

## Single-phase

Technical parameters	PVU/Z-100 /120	PVU/Z-173 /240	PVU/Z-380 /480	PVO/H-100 /120	PVO/H-173 /240	PVO/H-380 /480	PVB-100 /120	PVB-173 /240	PVB-380 /480
Under voltage protection (de-energise on trip)	•	•	•				•	•	•
Over voltage protection (energise on trip)				•	•	•	•	•	•
System type	1-phase (1-)	1-phase (1-)	1-phase (1-)	1-phase (1-)	1-phase (1-)	1-phase (1-)	1-phase (1-)	1-phase (1-)	1-phase (1-)
Voltage input terminals	L1, N								
Nominal voltage (L-N) (Adjustable)	57.7, 63.5, 69.3V	100, 110, 115, 120, 127, 139V	220, 230, 240, 254, 265, 277V	57.7, 63.5, 69.3V	100, 110, 115, 120, 127, 139V	220, 230, 240, 254, 265, 277V	57.7, 63.5, 69.3V	100, 110, 115, 120, 127, 139V	220, 230, 240, 254, 265, 277V
Voltage burden (max)	1VA/0.7W		1VA/0.7W	1.8VA/1.1W PV/H-380/480			3VA/1.7W		
Operating frequency AC	45-65 Hz								
Trip level adjustment under Umin	Adjustable 75-100% Un								
Trip level adjustment over Umax	Adjustable 100-125% Un								
Overload capacity -continuous: (L-N)	87V	174V	346V	87V	174V	346V	87V	174V	346V
-max. 10s: (L-N)	104V	209V	416V	104V	209V	416V	104V	209V	416V
Opening level off (L-N)	38V	66V	145V	38V	66V	250V	38V	66V	145V
Differential (hysteresis)	Adjustable 1-15% Un								
Time delay	Adjustable 0.5-10s (t)								
Output relay-contact	1x change over (AgNi) plated								
Output relay-contact terminals	15, 16, 18	15, 16, 18	15, 16, 18	15, 16, 18	15, 16, 18	15, 16, 18	Under 25, 26, 28/Over 15, 16, 18		
Load capability of Relay contact AC	250V/8A, max. 2000VA								
Load capability of Relay contact DC	30V/8A								
Mechanical life	3x10 <sup>6</sup> by rated load								
Relay reset	Automatic								
ANSI no.	27	27	27	59	59	59	27/59	27/59	27/59
Operating temp	-20 +55°C								
Storage temp	-30 +70°C								
Electric strength (supplying - contact relay)	4kV/1min.								
Overvoltage category	III.								
Pollution degree	2								
Enclosure integrity	IP40 from the front panel /IP10 terminals		IP40 from the front panel/ IP20 terminals	IP40 from the front panel /IP10 terminals			IP40 from the front panel/IP20 terminals		
Enclosure style	DIN-rail, 1 module			DIN-rail, 1 module			DIN-rail, 3 module		
Case material	Flame retardant polycarbonate								
Connecting conductors profile (mm <sup>2</sup> )	max.2x2.5mm <sup>2</sup> /1x4mm <sup>2</sup>		max.2x1.5mm <sup>2</sup> /1x2.5mm <sup>2</sup>	max.2x2.5mm <sup>2</sup> /1x4mm <sup>2</sup>			max.2x1.5mm <sup>2</sup> /1x2.5mm <sup>2</sup>		
Dimensions	90x17.6 x 64mm						90x52x65mm		
Weight	65g						125g		
Standards	EN 60255-6, EN 60255-27, EN 61000-6-2, EN 6100-6-4								

## Connection

### PVU/Z, PVO/H

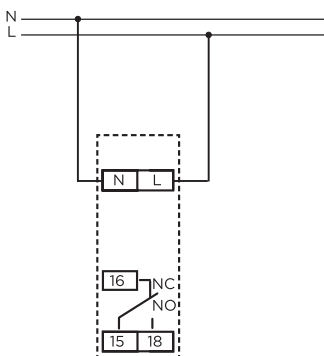

### PVB

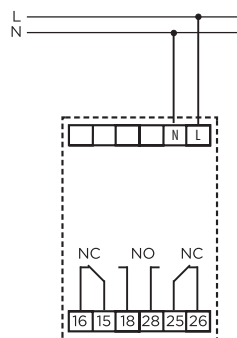

# AC Voltage

## Three-phase three-wire

Technical parameters	PVK/J-100 /120	PVK/J-173 /240	PVK/J-380 /480	PVA/C-100 /120	PVA/C-173 /240	PVA/C-380 /480	PVM-100 /120	PVM-173 /240	PVM-380 /480
Under voltage protection (De-energise on trip)	•	•	•				•	•	•
Over voltage protection (energise on trip)				•	•	•	•	•	•
System type	3-phase 3-wire (3-)	3-phase 3-wire (3-)	3-phase 3-wire (3-)	3-phase 3-wire (3-)	3-phase 3-wire (3-)	3-phase 3-wire (3-)	3-phase 3-wire (3-)	3-phase 3-wire (3-)	3-phase 3-wire (3-)
Voltage Input terminals	L1, L2, L3								
Nominal voltage (L-L) (Adjustable)	100, 110, 120V	173, 190, 200, 208, 220, 240V	380, 400, 415, 440, 460, 480V	100, 110, 120V	173, 190, 200, 208, 220, 240V	380, 400, 415, 440, 460, 480V	100, 110, 120V	173, 190, 200, 208, 220, 240V	380, 400, 415, 440, 460, 480V
Voltage burden (max)	1VA/0.7W		3VA/1.7W	1.8VA/1.1W		3VA/1.7W			
Operating frequency AC:	45-65 Hz								
Trip level adjustment under Umin	Adjustable 75-100% Un								
Trip level adjustment under Umax	Adjustable 100-125% Un								
Overload capacity -continuous: (L-L)	150V	300V	600V	150V	300V	600V	150V	300V	600V
-max. 3s: (L-L)	180V	360V	720V	180V	360V	720V	180V	360V	720V
Opening level off (L-L)	73V	126V	277V	73V	126V	277V	73V	126V	277V
Differential (hysteresis)	Adjustable 1-15% Un								
Time delay	Adjustable 0.5-10s (t)								
Output relay-contact	1x change over (AgNi) plated		2x change over (AgNi) plated	1x change over (AgNi) plated		2x change over (AgNi) plated			
Output relay-contact terminals	15, 16, 18	15, 16, 18	15, 16, 18 & 25, 26, 28	15, 16, 18	15, 16, 18	15, 16, 18 & 25, 26, 28	Under 15, 16, 18/Over 25, 26, 28		
Load capability of Relay contact AC	250V/8A, max.2000VA								
Load capability of Relay contact DC	30V/8A								
Mechanical life	3x10 <sup>6</sup> by rated load								
Relay reset	Automatic								
ANSI no.	27	27	27	59	59	59	27/59	27/59	27/59
Operating temp	-20 +55°C								
Storage temp	-30 +70°C								
Electric strength (supplying - contact relay)	4kV/1min.								
Overvoltage category	III.								
Pollution degree	2								
Enclosure integrity	IP40 from the front panel /IP10 terminals		IP40 from the front panel/ IP20 terminals	IP40 from the front panel /IP10 terminals		IP40 from the front panel/IP20 terminals			
Enclosure style	DIN-rail, 1 module		DIN-rail, 3 module	DIN-rail, 1 module		DIN-rail, 3 module			
Case material				Flame retardant polycarbonate					
Connecting conductors profile (mm <sup>2</sup> )	max.2x2.5mm <sup>2</sup> /1x4mm <sup>2</sup>		max.2x1.5mm <sup>2</sup> /1x2.5mm <sup>2</sup>	max.2x2.5mm <sup>2</sup> /1x4mm <sup>2</sup>		max.2x1.5mm <sup>2</sup> /1x2.5mm <sup>2</sup>			
Dimensions	90x17.6x64mm		90x52x65mm	90x17.6x64mm		90x52x65mm			
Weight	65g		125g	65g		125g			
Standards	EN 60255-6, EN 60255-27, EN 61000-6-2, EN 6100-6-4								

## Connection

PVK/J, PVA/C (100/120, 173/240)

PVM (100/120, 173/240, 380/480)  
PVK/J, PVA/C (380/480)

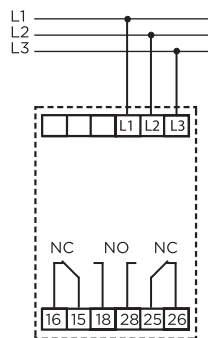
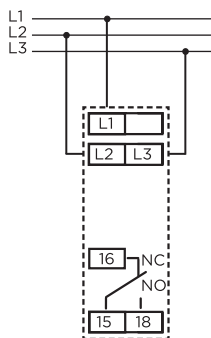

# AC Voltage

## Three-phase four-wire

Technical parameters	PVV/X-100 /120	PVV/X-173 /240	PVV/X-380 /480	PVP/S-100 /120	PVP/S-173 /240	PVP/S-380 /480	PVE-100 /120	PVE-173 /240	PVE-380 /480
Under voltage protection (de-energise on trip)	•	•	•				•	•	•
Over voltage protection (energise on trip)				•	•	•	•	•	•
System type	3-phase 4-wire (3-)	3-phase 4-wire (3-)	3-phase 4-wire (3-)	3-phase 4-wire (3-)	3-phase 4-wire (3-)	3-phase 4-wire (3-)	3-phase 4-wire (3-)	3-phase 4-wire (3-)	3-phase 4-wire (3-)
Voltage input terminals	L1, L2, L3, N								
Nominal voltage (L-N) (Adjustable)	57.7, 63.5, 69.3V	100, 110, 115, 120, 127, 139V	220, 230, 240, 254, 265, 277V	57.7, 63.5, 69.3V	100, 110, 115, 120, 127, 139V	220, 230, 240, 254, 265, 277V	57.7, 63.5, 69.3V	100, 110, 115, 120, 127, 139V	220, 230, 240, 254, 265, 277V
Voltage burden (max)	1VA/0.7W		3VA/1.7W	1.8VA/1.1W		3VA/1.7W			
Operating frequency AC	45-65 Hz								
Trip level adjustment Under Umin	Adjustable 75-100% Un								
Trip level adjustment Under Umax	Adjustable 100-125% Un								
Overload capacity -continuous: (L-N)	87V	174V	346V	87V	174V	346V	87V	174V	346V
-max. 10s: (L-N)	104V	209V	416V	104V	209V	416V	104V	209V	416V
Opening level off (L-N)	38V	66V	145V	38V	66V	145V	38V	66V	145V
	42V	73V	161V	42V	73V	161V	42V	73V	161V
Differential (hysteresis)	Adjustable 1-15% Un								
Time delay	Adjustable 0.5-10s (t)								
Output relay-contact	1x change over (AgNi) plated		2x change over (AgNi) plated	1x change over (AgNi) plated		2x change over (AgNi) plated			
Output relay-contact terminals:	15, 16, 18	15, 16, 18	15, 16, 18 & 25, 26, 28	15, 16, 18	15, 16, 18	15, 16, 18 & 25, 26, 28	Under 15, 16, 18/Over 25, 26, 28		
Load capability of Relay contact AC	250V/8A, max. 2000VA								
Load capability of Relay contact DC	30V/8A								
Mechanical life	3x10 <sup>6</sup> by rated load								
Relay reset	Automatic								
ANSI no.	27	27	27	59	59	59	27/59	27/59	27/59
Operating temp	-20 +55°C								
Storage temp	-30 +70°C								
Electric strength (supplying - contact relay)	4kV/1min.								
Over voltage category	III.								
Pollution degree	2								
Enclosure integrity	IP40 from the front panel /IP10 terminals		IP40 from the front panel/ IP20 terminals	IP40 from the front panel /IP10 terminals		IP40 from the front panel/IP20 terminals			
Enclosure style	DIN-rail, 1 module		DIN-rail 3 module	DIN-rail, 1 module		DIN-rail, 3 module			
Case material	Flame retardant polycarbonate								
Connecting conductors profile (mm <sup>2</sup> )	max. 2x2.5mm <sup>2</sup> /1x4mm <sup>2</sup>		max. 2x1.5mm <sup>2</sup> /1x2.5mm <sup>2</sup>	max. 2x2.5mm <sup>2</sup> /1x4mm <sup>2</sup>		max. 2x1.5mm <sup>2</sup> /1x2.5mm <sup>2</sup>			
Dimensions	90x17.6x64mm		90x52x65mm	90x17.6x64mm		90x52x65mm			
Weight	65g		125g	65g		125g			
Standards	EN 60255-6, EN 60255-27, EN 61000-6-2, EN 6100-6-4								

## Connection

### PVV/X, PVP/S (100/120, 173/240)

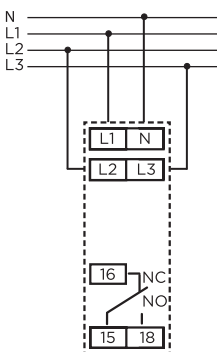

### PVE (100/120, 173/240, 380/480) PVV/X, PVP/S (380/480)

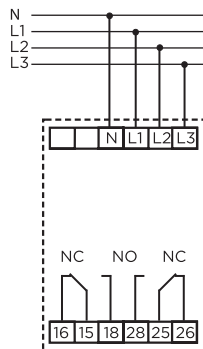

## Frequency

The Frequency protector trip relay provides a continuous surveillance of the monitored circuits and offers user adjustable trip points (set points) with time delay and differential (hysteresis) settings. When the frequency moves outside the set point limits for longer than the time delay, the relay will operate giving an alarm control or tripping signal. Since speed is proportional to frequency, this protector can be used to monitor under and over speed to protect mains, computers supplies and standby supplies.

### Basic Parameters

- Adjustable rated frequency, 50, 60 or 400Hz
- Trip level adjustment between 80-120% (Fn) Under
- Trip level adjustment between 80-120% (Fn) Over
- Adjustable differential (hysteresis) 0.5-5%
- Adjustable time delay 0.5-10s (t)
- Power on LED (green)

### Under and Over Frequency

- Continuously monitors frequency to provide under and over frequency protection (set level  $F_{min}$  and  $F_{max}$ )
- Three module version
- 2 output relays

Part no.	1-phase
PHD	x

### Under and Over Frequency - PHD

The Frequency protector set point adjustment range is centred around the nominal system frequency of 50, 60 or 400Hz. The adjustable differential setting can be used to reduce nuisance tripping if the measured signal is noisy or unstable. Under normal conditions, with the supply frequency close to the nominal set point, both red LEDs are off with the Under relay energised and the Over relay de-energised. Should the supply fall below the opening threshold, both relays will de-energise and both red LEDs will flash slowly to indicate insufficient supply voltage.

### Under protection

Should the monitored frequency falls below the set point level,  $F_{min}$ , the protector trips and the red LED illuminates to indicate the fault condition. During the time delay period the red LED will flash for the set time, (t), before the relay de-energises (output relay-contact terminals 15, 16 & 18). The relay automatically resets once the monitored frequency rises above the set point level  $F_{min}$  plus the differential (between 0.5-5%). Causing the red LED to extinguish and the relay to make without time delay.

### Over protection

Should the monitored frequency exceed the set point level  $F_{max}$ , the protector trip and the red LED illuminates to indicate the fault condition. During the time delay period the red LED will flash for the set time (t) before the relay energises (output relay-contacts terminals 25, 26 & 28). The relay automatically resets once the monitored frequency falls below the set point level  $F_{max}$  plus the differential (between 0.5-5%). Causing the red LED to extinguish and the relay to release without time delay.

**Note: Red LED indicates fault condition, not relay status**

### Characteristics

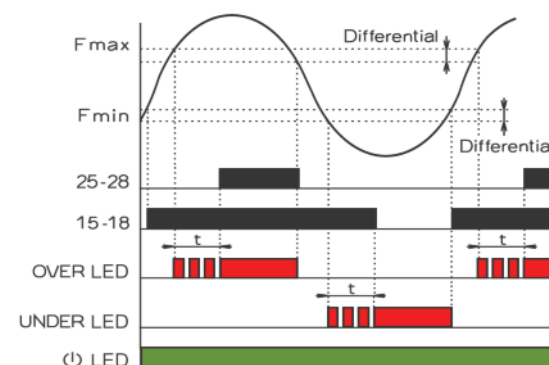

# Frequency

## Single-phase

Technical parameters	PHD-100/120	PHD-173/240	PHD-380/480
Under frequency protection (de-energise on trip)	•	•	•
Over frequency protection (energise on trip)	•	•	•
System type	1-phase (1-)	1-phase (1-)	1-phase (1-)
Supply input terminals		L, N	
Supply voltage	43-87V	71-174V	161-346V
Rated frequency Fn		50/60/400 Hz	
Supply input burden (max)		1.6VA/1W approx	
Supply opening threshold Uopen	43V	71V	161V
Under frequency range Fmin		Adjustable 80-120% In	
Over frequency range Fmax		Adjustable 80-120% In	
Overload capacity			
-continuous	87V	174V	346V
-max. 10s	104V	209V	416V
Differential (hysteresis)		Adjustable 0.5-5% Fn	
Time delay		Adjustable 0.5-10s	
Output relay-contact		2x change over (AgNi) plated	
Output relay-contact terminals		Under 15, 16, 18/Over 25, 26, 28	
Load capability of relay contact AC		250V/8A, max.2 KVA	
Load capability of relay contact DC		30V/8A	
Mechanical life		3x10 <sup>6</sup> by rated load	
Relay reset		Automatic	
ANSI no.		810/U	
Operating temperature		-20 +55°C	
Storage temperature		-30 +70°C	
Electric strength (supplying-contact relay)		4kV/1min.	
Overvoltage category		III.	
Pollution degree		2	
Enclosure integrity		IP40 from the front panel/IP20 terminals	
Enclosure style		DIN-rail, 3 module	
Case material		Flame retardant polycarbonate	
Connecting conductors profile (mm <sup>2</sup> )		max.2x1.5mm <sup>2</sup> /1x2.5mm <sup>2</sup>	
Dimensions		90x52x64mm	
Weight		124g approx	
Standards		EN 60255-6, EN 60255-27, EN61000-6-2, EN6100-6-4	

## Protector Overview PHD

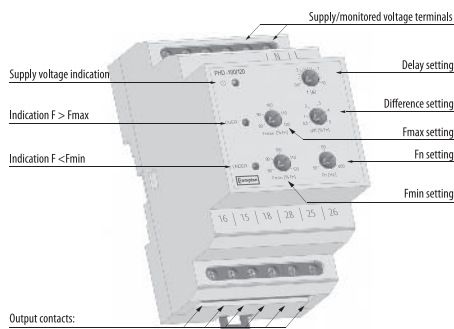

## Connection PHD

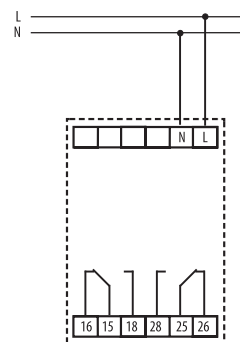

# Phase Sequence and Phase Failure

The phase sequence and phase failure protector trip relay is designed to monitor the correct phase rotation or sequence of a three-phase supply system. It provides protection against incorrect phase sequence, loss of one phase and under voltage. Two versions are available to suit either three-phase three-wire (PVR3) or three-phase four-wire (PVR4) systems.



### Basic Parameters

- Available with three voltage ranges 100-120V, 173-240V & 380-480V ( $U_n$ )
- Adjustable nominal voltage range
- Power on LED (green)
- Fixed differential (hysteresis) 1%

Part no.	3-phase 3-wire	3-phase 4-wire	Protection
PVR3	x		Phase sequence, under voltage 85%
PVR4		x	Phase sequence, under voltage 85%

### Operation

Applications where the involvement of three-phase motors which can rotate in the wrong direction, potentially could lead to physical damage or risk of injury to personnel, yet voltage and current readings may still appear normal. If one phase is lost because of a blown fuse, electric motors can continue to operate (single-phasing) which can result in severe electrical or mechanical damage. For permanent installations, this relay should be used to monitor the incoming supply, protecting all equipment against incorrect connection at initial installation or after maintenance work. Rotating machines that can not tolerate reverse rotation or pose significant risk to personnel under this condition should be individually protected with this relay.

The phase sequence and phase failure protector continuously monitors the three-phase supply. With the correct phase sequence applied, the front panel LED will be off and the relay energised. An incorrect sequence or missing phase will de-energise the relay and the LED will illuminate showing a fault condition. The supply falling below 85% of its nominal voltage will also cause a trip.

Note: If one phase is lost due to a blown fuse, some loads can re-generate the missing voltage. This relay can be used as a phase failure relay providing the regenerated voltage in open phase is less than 70% of the nominal supply voltage. If there is the possibility of a higher regenerated voltage, the phase balance PSF should be used.

### Characteristics

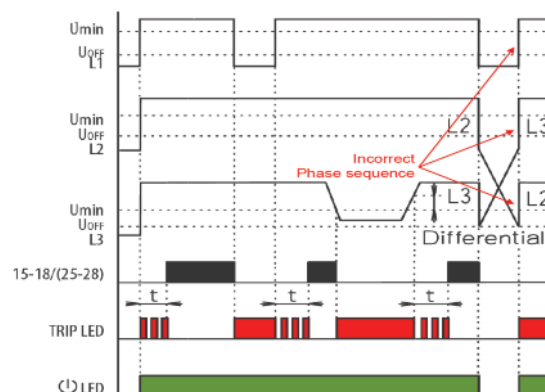



# Phase Sequence and Phase Failure

Technical parameters	PVR3-100/120	PVR3-173/240	PVR3-380/480	PVR4-100/120	PVR4-173/240	PVR4-380/480
Phase sequence under voltage 85% (de-energise on trip)	•	•	•	•	•	•
System type	3-phase 3-wire (3-)	3-phase 3-wire (3-)	3-phase 3-wire (3-)	3-phase 4-wire (3-)	3-phase 4-wire (3-)	3-phase 4-wire (3-)
Supply input terminals		L1, L2, L3			L1, L2, L3, N	
Rated voltage Un (V nom)	100, 110, 120	173, 190, 200, 208, 220, 240	380, 400, 415, 440, 460, 480	57.7, 63.5, 69.3	100, 110, 115, 120, 127, 139	220, 230, 240, 254, 265, 277
Operating frequency	45-65 Hz					
Supply input burden (max)	3VA/1.7W approx			2.5VA/1.4W approx		
Supply threshold (Umin)	Fixed at 85% of V nom					
Overload capacity						
-continuous	150V	300V	600V	87V	174V	346V
-max. 10s	180V	360V	720V	104V	209V	416V
Differential (hysteresis)	Fixed at 1% of V nom					
Trip reset delay	Fixed at 0.5s					
Output relay-contact	1x change over (AgNi) plated		2x change over (AgNi) plated	1x change over (AgNi) plated		2x change over (AgNi) plated
Output relay-contact terminals	15, 16, 18	15, 16, 18	15, 16, 18 & 25, 26, 28	15, 16, 18	15, 16, 18	15, 16, 18 & 25, 26, 28
Load capability of relay contact AC	250V/8A, max.2 KVA					
Load capability of relay contact DC	30V/8A					
Mechanical life	3x10 <sup>6</sup> by rated load					
Relay reset	Automatic					
ANSI no.	47					
Operating temperature	-20 +55°C					
Storage temperature	-30 +70°C					
Electric strength (supplying - contact relay)	4kV/1min.					
Overvoltage category	III.					
Pollution degree	2					
Enclosure integrity	IP40 from the front panel/ IP10 terminals		IP40 from the front panel/ IP20 terminals	IP40 from the front panel/ IP10 terminals		IP40 from the front panel /IP20 terminals
Enclosure style	DIN-rail, 1 module		DIN-rail, 3 module	DIN-rail, 1 module		DIN-rail, 3 module
Case material	Flame retardant polycarbonate					
Connecting conductors profile (mm <sup>2</sup> )	max.2x2.5mm <sup>2</sup> /1x4mm <sup>2</sup>		max.2x1.5mm <sup>2</sup> /1x2.5mm <sup>2</sup>	max.2x2.5mm <sup>2</sup> /1x4mm <sup>2</sup> 90x17.6x64mm/1x2.5mm <sup>2</sup>		max.2x1.5mm <sup>2</sup>
Dimensions	90x17.6x64mm		90x52x64mm	90x17.6x64mm		90x52x64mm
Weight	63g approx		121g approx	63g approx		121g approx
Standards	EN 60255-6, EN 60255-27, EN61000-6-2, EN6100-6-4					

## Protector Overview

### PVR3/4 (100/120, 173/240)

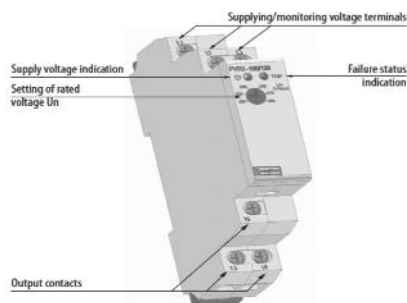

### PVR3/4 (380/480)

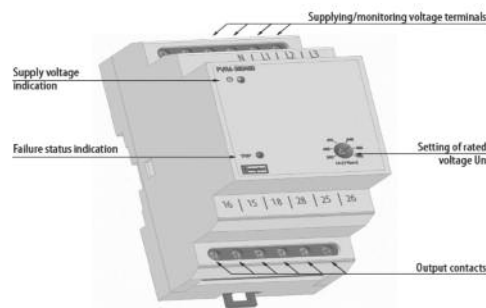

## Connection PVR3/4

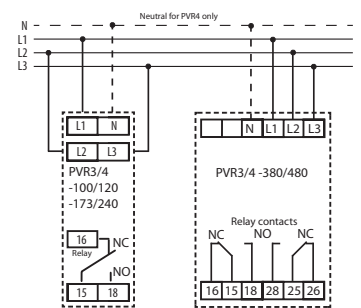

# Phase Balance, Sequence and Voltage Monitor

The phase balance, sequence and voltage protector trip relay, is designed to monitor a three-phase supply for phase imbalance, low or missing phases or incorrect phase sequence and to trip a relay if it detects any anomaly. Two versions are available to suit either three-phase three-wire (PSF/G3) or three-phase four-wire (PSF/G4) systems.

## Basic Parameters

- Available with three voltage ranges 100-120V, 173-240V and 380-480V ( $U_n$ )
- Adjustable nominal voltage range
- Adjustable trip delay 0.5-10s
- Adjustable low voltage trip level 50-85%
- Adjustable phase imbalance trip level 5-15%
- Power on LED (green)
- Fixed differential (hysteresis) 1%

Part no.	3-phase 3-wire	3-phase 4-wire	Protection
PSF/G3	x		Phase sequence, phase balance and under voltage
PSF/G4		x	Phase sequence, phase balance and under voltage

## Operation

Rotating machines are particularly vulnerable to incorrect phase sequence, and rotate in the wrong direction, potentially leading to physical damage or the risk of injury to personnel. If one phase is lost because of a blown fuse, electric motors can continue to operate (single-phasing) which can result in severe electrical or mechanical damage.

The PSF protector continuously monitors the three-phase supply, with all correct phase sequence applied and all three voltages balanced within the required limits the front panel, the LED will be off and the relay energised. An incorrect sequence, missing phase, out of balance or under voltage condition will de-energise the relay and the LED will illuminate. The set point control allows adjustment of the voltage imbalance, if one phase voltage differs from the other by more than the set percentage, between 5% and 15%, than the relay will de-energise and the LED will illuminate. The time delay function operates only for the voltage imbalance condition. This delay can be used to prevent nuisance tripping due to short term imbalance situations.

## Characteristics

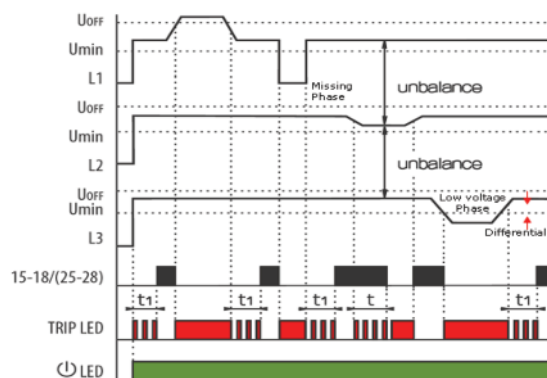

# Phase Balance, Sequence and Voltage Monitor

Technical parameters	PSF/G3-100/120	PSF/G3-173/240	PSF/G3-380/480	PSF/G4-100/120	PSF/G4-173/240	PSF/G4-380/480
Phase loss, imbalance and under voltage (de-energise on trip)	•	•	•	•	•	•
System type	3-phase 3-wire (3-)	3-phase 3-wire (3-)	3-phase 3-wire (3-)	3-phase 4-wire (3-)	3-phase 4-wire (3-)	3-phase 4-wire (3-)
Supply input terminals	L1, L2, L3					
Rated voltage Un (V nom)	100, 110, 120	173, 190, 200, 208, 220, 240	380, 400, 415, 440, 460, 480	57.7, 63.5, 69.3	100, 110, 115, 120, 127, 139	220, 230, 240, 254, 265, 277
Operating frequency	45-65 Hz					
Supply input burden (max)	3VA/1.7W approx			2.5VA/1.4W approx		
Phase imbalance trip level (V nom)	Adjustable 5-15% Un (V nom)					
Differential (hysteresis)	Fixed at 1% of V nom					
Low-voltage trip level (Umin)	Adjustable 50-85% Un (V nom)					
Trip delay t	Adjustable 0.5-10s					
Trip reset delay t1	Fixed at 0.5s					
Overload capacity						
-continuous	150V	300V	300V	87V	174V	346V
-max. 10s	180V	360V	600V	104V	209V	416V
Max operating voltage (Uoff)	187V	374V	749V	108V	216V	432V
Differential (hysteresis)	Fixed at 1% of V nom					
Output relay-contact	1x change over (AgNi) plated		2x change over (AgNi) plated	1x change over (AgNi) plated		2x change over (AgNi) plated
Output relay-contact terminals	15, 16, 18	15, 16, 18	15, 16, 18 & 25, 26, 28	15, 16, 18	15, 16, 18	15, 16, 18 & 25, 26, 28
Load capability of relay contact AC	250V/8A, max.2 KVA					
Load capability of relay contact DC	30V/8A					
Mechanical life	3x10 <sup>6</sup> by rated load					
Relay reset	Automatic					
ANSI no.	47					
Operating temperature	-20 +55°C					
Storage temperature	-30 +70°C					
Electric strength (supplying - contact relay)	4kV/1min.					
Overvoltage category	III.					
Pollution degree	2					
Enclosure integrity	IP40 from the front panel/ IP10 terminals		IP40 from the front panel/ IP20 terminals	IP40 from the front panel/ IP10 terminals		IP40 from the front panel /IP20 terminals
Enclosure style	DIN-rail, 1 module		DIN-rail, 3 module	DIN-rail, 1 module		DIN-rail, 3 module
Case material	Flame retardant polycarbonate					
Connecting conductors profile (mm <sup>2</sup> )	max.2x2.5mm <sup>2</sup> /1x4mm <sup>2</sup>		max.2x1.5mm <sup>2</sup> /1x2.5mm <sup>2</sup>	max.2x2.5mm <sup>2</sup> /1x4mm <sup>2</sup>		max.2x1.5mm <sup>2</sup> /1x2.5mm <sup>2</sup>
Dimensions	90x17.6x64mm		90x52x64mm	90x17.6x64mm		90x52x64mm
Weight	63g approx		121g approx	63g approx		121g approx
Standards	EN 60255-6, EN 60255-27, EN61000-6-2, EN6100-6-4					

## Protector Overview

### PSF/G3/4 (100/120, 173/240)

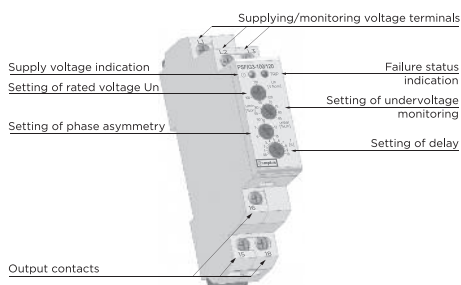

### PSF/G3/4 (380/480)

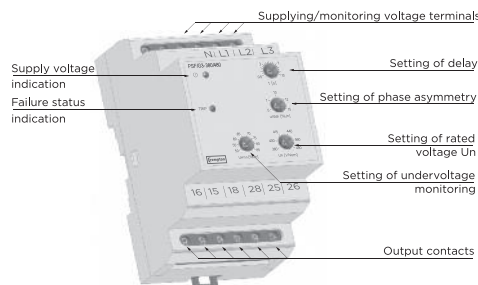

## Connection

### PSF/G3/4

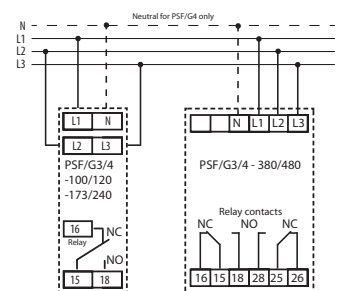

# Synchro-check (Paralleling)

The Synchro-check (paralleling) protector trip relay compares the voltage, frequency and phase angle of two supplies and operates a relay according to the state of synchronisation of the supplies. If the two supplies are not synchronised, the relay operates to provide a control output. The relay output can be used for alarm or control purposes.

The unit also provides a dead bus function. If the bus supply fails, the relay operates and the output can be used to switch in an emergency generator.

### Basic Parameters

- Available with three voltage ranges
- Adjustable nominal voltage range
- Adjustable synch tolerance
- Dead bus function on/off switch
- Power on LED (green)

Part no.	1-Phase, 3-Phase 3-wire/4-wire	Protection
PLL/D	x	Phase angle and voltage dead bus option

### Operation

As part of a manual control system, the operator will make adjustments to generator voltage (excitation) and frequency (engine speed) using a synchroscope or lamps and will then attempt to manually close the breaker. This synchro check protector will qualify that two systems are closely matched before permitting the breaker to close. As part of an automatic synchronising arrangement, the synchro-check (paralleling) trip relay can be used as an independent backup or checking device to ensure the two systems are suitably matched before the breaker can close.

The synchro-check (paralleling) trip relay continuously monitors the voltage, phase displacement and frequency of the two supplies. While the two supplies match in volts, frequency and phase to the degree set by the %Volts control, the sync LED illuminates and the relay is energised, indicating that the two supplies are matched and it is safe to close the breaker. The relay is fitted with a selectable Dead Bus detection function. If there is a requirement for a continuous supply or emergency power, then the generator can be connected without synchronising, thus ensuring continuity of supply. The absence of the bus voltage will cause the relay to energise.

### Characteristics

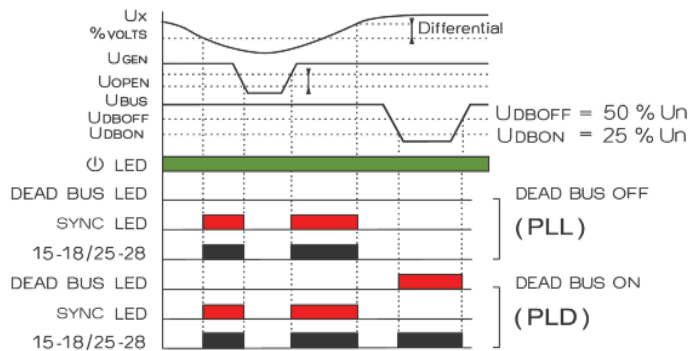

# Synchro-check (Paralleling)

Technical parameters	PLL/D-100/120	PLL/D-173/240	PLL/D-380/480
Phase angle and voltage dead bus option (energise on trip)	•	•	•
System type	1-phase (1-), 3-phase 4-wire (3-)		
Input terminals (generator)	A1, A2		
Input terminals (busbar)	A3, A4		
Rated voltage Un (V nom) L-N	57.7, 63.5, 69.3	100, 110, 115, 120, 127, 139	220, 230, 240, 254, 265, 277
Operating frequency	45-65 Hz		
Supply input burden (max)	2VA/1.6W approx	2.7VA/1.7W approx	4VA/2.2W approx
Dead bus on Udbon	25% Uon		
Dead bus off Udboff	50% Uon		
Sync tolerance	Adjustable 10-30% volts		
Overload capacity			
-continuous	87V	174V	346V
-max. 10s	104V	209V	416V
Opening level (Uopen)	35V	60V	132V
Output relay-contact	2x change over (AgNi) plated		
Output relay-contact terminals	15, 16, 18 & 25, 26, 28		
Load capability of relay contact AC	250V/8A, max.2 KVA		
Load capability of relay contact DC	30V/8A		
Mechanical life	3x10 <sup>6</sup> by rated load		
Relay reset	Automatic		
ANSI no.	25		
Operating temperature	-20 +55°C		
Storage temperature	-30 +70°C		
Electric strength (supplying -contact relay)	4kV/1min.		
Overvoltage category	III.		
Pollution degree	2		
Enclosure integrity	IP40 from the front panel/IP20 terminals		
Enclosure style	DIN-rail, 6 module		
Case material	Flame retardant polycarbonate		
Connecting conductors profile (mm <sup>2</sup> )	max.2x1.5mm <sup>2</sup> /1x2.5mm <sup>2</sup>		
Dimensions	90x105x64mm		
Weight	291g approx	335g approx	332g approx
Standards	EN 60255-6, EN 60255-27, EN61000-6-2, EN6100-6-4		

## Protector Overview

### PLL/D

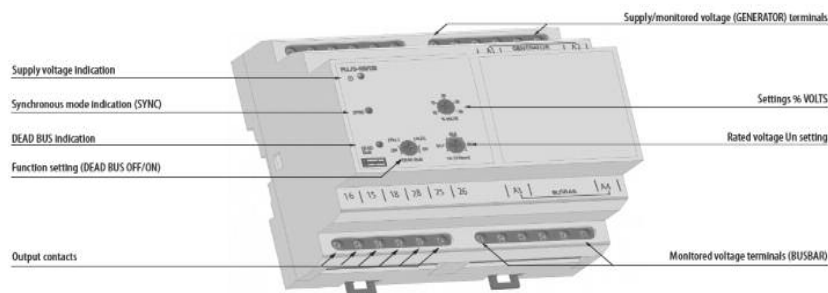

## Connection

### PLL/D

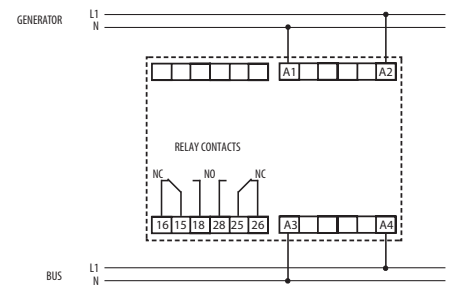

## Reverse Power (Current)

The Reverse Power protector trip relay monitors a single- or three-phase supply for reverse power and trips a relay if it detects reverse power ( $I \times \cos \Phi$ ) over a set limit. The relay output is typically used to prevent 'motoring' of a generator (where the generator turns the engine), which can damage the engine.

### Basic Parameters

- Available with three voltage ranges 100-120V, 173-240V and 380-480V ( $U_n$ )
- Adjustable nominal current range, 2, 3, 4, 5, 8 & 10 Amps ( $I_n$ )
- Adjustable trip delay 0.5-20s
- Adjustable set point 2-20%
- Power on LED (green)

Part no.	3-phase 3-wire	3-phase 4-wire	Protection
PAT	x		Reverse power 2-20%
PAS		x	Reverse power 2-20%

### Operation

The Reverse Power trip relay provides continuous surveillance of AC generators against motoring. Reverse power relays are used to detect the failure of the prime mover (engine) when active energy (Watts) flows into the generator causing rotation - the set will operate like an electric motor which can cause significant mechanical damage. This relay offers an adjustable reverse power set between 2% and 20% of the nominal power and time delay adjustment range of 0 to 20 seconds. The protector relay estimates the power level in the system by measuring current and power factor, but does not actually measure the system voltage. When the reverse power level exceeds the set point, and after the time delay has elapsed, the relay will energise and the red LED will illuminate to indicate the trip condition. The relay will automatically reset once the power level falls below the set point minus the fixed differential of 1% causing the LED to extinguish and the relay to de-energise.

Note: The % set potentiometer trimmer on the front label is calibrated as a percentage of the current rating e.g. of 5A and not of the forward kW.

### Characteristics

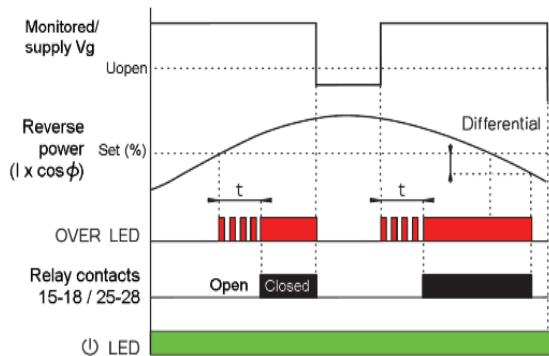

# Reverse Power (Current)

Technical parameters	PAT-100/120	PAT-173/240	PAT-380/480	PAS-100/120	PAS-173/240	PAS-380/480
Reverse power (energise on trip)	•	•	•	•	•	•
System type	3-phase 3-wire (3-)	3-phase 3-wire (3-)	3-phase 3-wire (3-)	1-phase, 3-phase 4-wire (3-)	1-phase, 3-phase 4-wire (3-)	1-phase, 3-phase 4-wire (3-)
Voltage input terminals	L1, L2, L3			L1, N		
Current input terminals	I1, I2					
Rated voltage Un (V nom)	100 - 120	173 - 240	380-480	57.7-69.3	100-139	220-277
Rated current In (A)	2A, 3A, 4A, 5A, 8A, 10A					
Operating frequency	45-65 Hz					
Supply input burden (max)	2.5VA/1.5W approx	4.2VA/3.2W approx	6VA/4W approx	1.4VA/1W approx	1.6VA/1.3W approx	2.9VA/2.1W approx
Monitored current range	2..100% In					
Monitored cos $\phi$ range	0.2 inductive to 0.2 capacitive					
Reverse power setpoint range	2..20% (cos $\phi$ =1)					
Differential (hysteresis)	Fixed at 1%					
Trip reset t	Adjustable 0.5-20s					
Overload capacity						
-continuous	3 x 150V	3 x 300V	3 x 600V	87V	174V	346V
-max. 10s	3 x 180V	3 x 360V	3 x 720V	104V	209V	416V
Opening level (Uopen)	3 x 60V	3 x 104V	3 x 228V	35V	60V	132V
Output relay-contact	2x change over (AgNi) plated					
Output relay-contact terminals	15, 16, 18 & 25, 26, 28					
Load capability of relay contact AC	250V/8A, max.2 KVA					
Load capability of relay contact DC	30V/8A					
Mechanical life	3x10 <sup>6</sup> by rated load					
Relay reset	Automatic					
ANSI no.	32					
Operating temperature	-20 +55°C					
Storage temperature	-30 +70°C					
Electric strength (supplying - contact relay)	4kV/1min.					
Overvoltage category	III.					
Pollution degree	2					
Enclosure integrity	IP40 from the front panel/IP20 terminals					
Enclosure style	DIN-rail, 6 module					
Case material	Flame retardant polycarbonate					
Connecting conductors profile (mm <sup>2</sup> )	max.2x1.5mm <sup>2</sup> /1x2.5mm <sup>2</sup>					
Dimensions	90x105x64 mm					
Weight	298g approx	340g approx	338g approx	248g approx	269g approx	268g approx
Standards	EN 60255-6, EN 60255-27, EN61000-6-2, EN6100-6-4					

## Protector Overview

### PAT & PAS

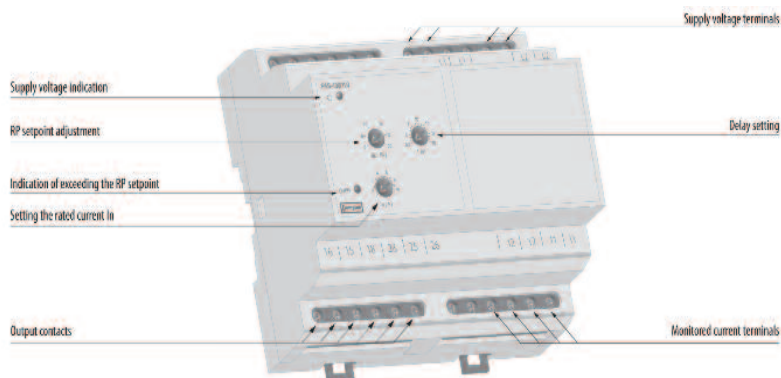

## Connection

### PAT

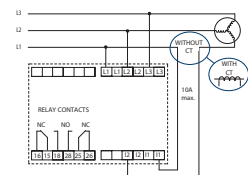

### PAS

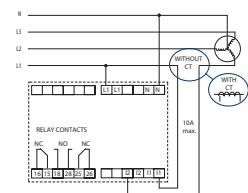

# DC Millivolts and Transducer

The DC Millivolts and Transducer trip relay protectors provide continuous surveillance of DC voltages or current signals. When the input signals move outside the set point limits the relay will operate and the fault LED will illuminate.

### Basic Parameters

- Adjustable rated DC current input 0-1mA, 0-10mA, 4-20mA (PBV)
- Adjustable rated DC voltage input 50mV, 75mV, 100mV (PBT/S)
- Trip level adjustment Low 0-80% ( $U_n$ )
- Trip level adjustment High 80-120% ( $U_n$ )
- Adjustable trip delay 0.5-10s
- Power on LED (green)

Part no.	Type	Protection
PBV	DC transducer	High 40-120% and low 0-80% trip
PBT/S	DC millivolts	High 40-120% and low 0-80% trip

### Operation

The DC Millivolts and Transducer trip relay offers adjustable low and high trip points (set points) and time delay settings. If the monitored signal exceeds either the Low or High set point, the time delay is started and the red LED will illuminate to indicate a trip condition. When the time delay has elapsed, the relay will energise. The relay will automatically reset once the monitor signal falls below the set point minus the differential set point. When reset the red LED will extinguish and the relay will de-energise.

### Characteristics

#### PBV

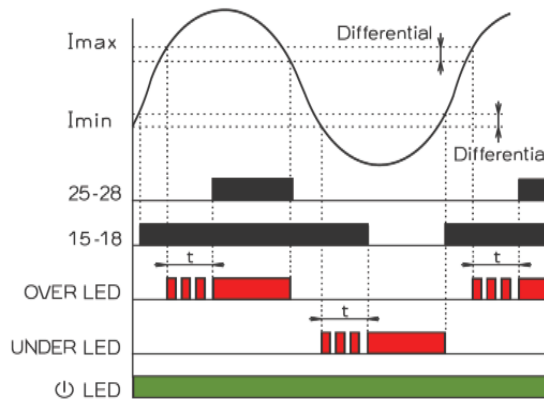

#### PBT/S

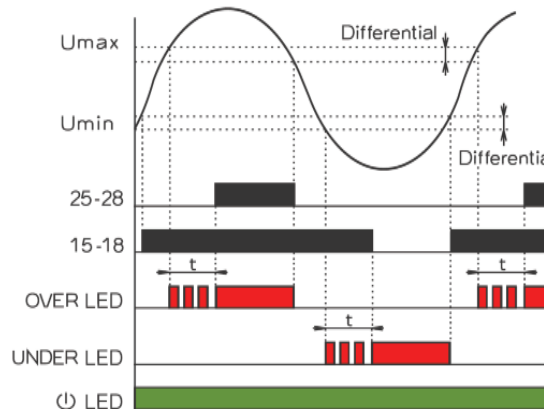



# DC Millivolts and Transducer

Technical parameters	PBT/S-12/24	PBT/S-24/240	PBV-12/24	PBV-24/240
DC millivolts trip	•	•		
DC transducer trip			•	•
Supply terminals	A1, A2			
Input/monitoring terminal	IN+, IN-			
Supply voltage	12-24V DC	24-240VAC/DC (AC 45-65Hz)	12-24V DC	24-240VAC/DC (AC 45-65Hz)
Supply voltage burden (max)	1W	3VA/0.9W	1W	3VA/0.9W
Supply voltage tolerance	+/-10%			
Rated input	50mV, 75mV, 100mV		0-1mA, 0-10mA, 4-20mA	
Input impedance	50kΩ		-	
Voltage drop across input	-		1V max. at 120% lin	
Over-range	40-120 %Uin		40-120 %lin	
Under-range	0-80 %Uin		0-80 %lin	
Differential	Fixed at 1%Uin		Fixed at 1%lin	
Trip time delay	Adjustable 0.5 to 10s			
Overload capacity continuous	10 x Uin		3 x lin	
Is max.	-		10 x lin	
Output relay-contact	2x change over (AgNi) plated			
Output relay-contact terminals	15, 16, 18 & 25, 26, 28			
Load capability of relay contact AC	250V/8A, max.2 KVA			
Load capability of relay contact DC	30V 8A			
Mechanical life	3x10 <sup>6</sup> by rated load			
Electrical life (AC1)	7 x 10 <sup>6</sup>			
ANSI no.	74			
Operating temperature	-20 +55°C			
Storage temperature	-30 +70°C			
Electric strength (supplying - contact relay)	4kV/1min.			
Overvoltage category	III.			
Pollution degree	2			
Enclosure integrity	IP40 from the front panel/IP20 terminals			
Enclosure style	DIN-rail, 3 module			
Case material	Flame retardant polycarbonate			
Connecting conductors profile (mm <sup>2</sup> )	max.2x1.5mm <sup>2</sup> /1x2.5mm <sup>2</sup>			
Dimensions	90x52x64mm			
Weight	135g approx			
Standards	EN 60255-6, EN 60255-27, EN61000-6-2, EN6100-6-4			

## Protector Overview

### PBV

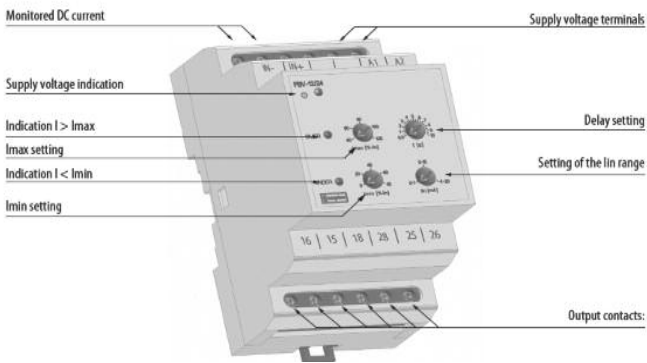

### PBT/S

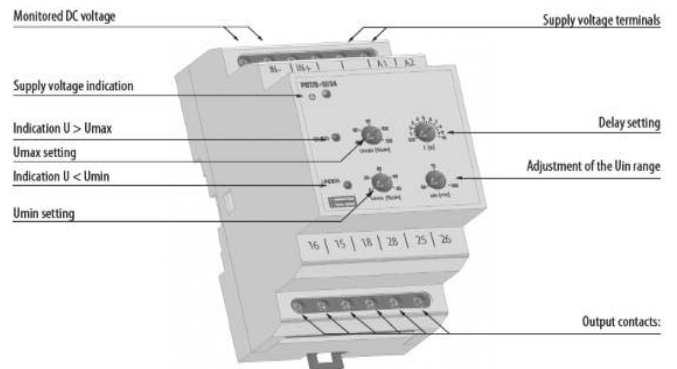

## Connection

### PBV, PBT/S

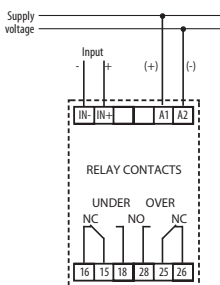

# Thermistor

The Thermistor protector trip relay monitors the temperature of a motor using the PTC sensor (positive temperature coefficient resistor) or thermostat (TK) switch built in to the motor winding. Relay contacts can be used to disconnect the supply to the motor should it overheat. LEDs indicate mains on and fault status.



### Basic Parameters

- Selectable PTC or TK modes
- Reset function
- Selectable memory function for latching
- Power on LED (green)

Part no.	Type	Protection
PMM/T	PTC, TK thermistors	Over-temperature

### Operation

The Thermistor protector trip relay operates by de-energising a relay and illuminating a red LED when the thermistor detects a critical temperature condition. Should the motor overheat and the PTC resistance go above the 3.3kOhms, the relays de-energise. The contacts remain de-energised until the PTC resistance falls to 1.8kOhms. The selectable memory switch allows the option of latching the relay and the red LED stays illuminated until the reset button is pressed or triggered via the external reset switch. Any number of thermistors may be used in series connection providing the resistance at normal working temperature is less than 1500 ohms.

### Characteristics

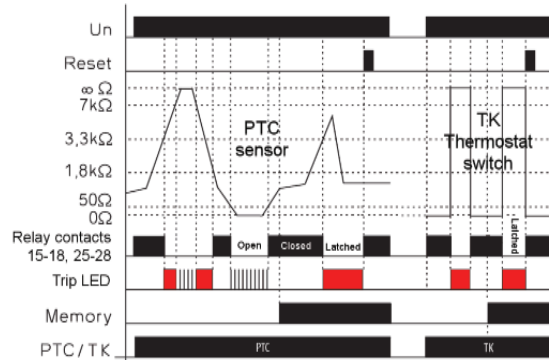

# Thermistor

Technical parameters	PMM/T-24/240
PTC, TK thermistor	•
System type	Monitoring temperature of motor winding
Supply terminals	A1, A2
Input/thermistor terminals	Ta, Tb
Supply voltage	AC/DC 24-240V (AC 45-65Hz)
Supply voltage burden (max)	2VA max
Supply voltage tolerance	-15/10%
PTC sensor ranges	
Cold	50Ω - 1.5 kΩ
Lower limit	1.8 kΩ
Upper limit	3.3 kΩ
Sensor failure indication	Red LED flashes
Repetition accuracy (mech)	<5%
Switching error	35%
Temperature dependence	<0.1%/°C
Output relay-contact	2x change over (AgNi) plated
Output relay-contact terminals	15, 16, 18 & 25, 26, 28
Load capability of relay contact AC	250V/8A, max.2 KVA
Load capability of relay contact DC	24V 8A 500mW min
Mechanical life	3x10 <sup>6</sup> by rated load
Electrical life (AC1)	7 x 10 <sup>6</sup>
ANSI no.	49
Operating temperature	-20 +55°C
Storage temperature	-30 +70°C
Electric strength (supplying -contact relay)	4kV/1min.
Oversvoltage category	III.
Pollution degree	2
Enclosure integrity	IP40 from the front panel/IP20 terminals
Enclosure style	DIN-rail, 1 module
Case material	Flame retardant polycarbonate
Connecting conductors profile (mm <sup>2</sup> )	max.2x1.5mm <sup>2</sup> /1x2.5mm <sup>2</sup>
Dimensions	90x17.6x64mm
Weight	83g approx
Standards	EN 60255-6, EN 60255-27, EN61000-6-2, EN6100-6-4

## Protector Overview

### PMM/T

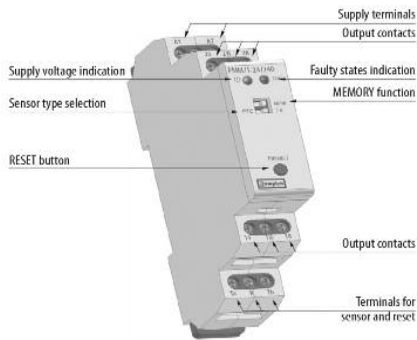

## Connection

### PMM/T

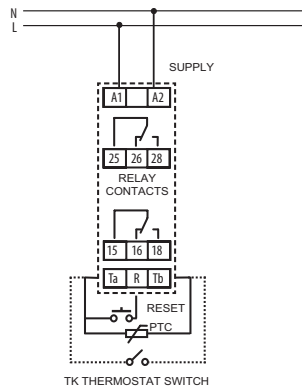

## Speed Sensing

The Speed Sensing protector trip relay monitors rotating equipment using a magnetic pick-up and provides three output contacts which can be used to initiate alarms or shutdown signals. The relay also provides a tachometer output for speed indication.

### Basic Parameters

- Magnetic pick up input
- 1mA output signal
- 3 adjustable rotation set points
- Power on LED (green)

Part no.	Type	Protection
PH3	Speed sensing	Crank 10 to 50% Under-speed 50 to 100% Over-speed 100 to 130%

### Operation

The Speed Sensing relay will detect under-speed, over-speed and stop conditions, the set points can be used to raise an alarm or shut down the monitored equipment. The front panel provides three user set trip levels with relay LED state indication and a speed indicator analogue output signal in the form of 0-1mA.

The relay can be calibrated such that the standard 100% of the relay represents the required nominal engine speed. This is achieved by supplying the appropriate input to the sensor input terminals and pressing the adjust button for more than 3 seconds thus tripping the relay to become 100% reference.

### Cranking Trip

The cranking function detects if the engine is running or stopped. This function can be used to ensure the cranking motor is disconnected once the engine has started running. The crank yellow LED illuminates and the relay energises when the engine speed exceeds the cranking setting. This is normally set just above the cranking speed of the crank motor to indicate the engine has started.

### Under-Speed Trip

The under speed red LED illuminates and the relay de-energises when the engine speed falls below the under-speed control setting minus the fixed 2% differential.

### Over-Speed Trip

Should the engine speed exceed the over-speed control setting, the over relay de-energises and the red over LED illuminates.

### Fail Safe Operation

Should the sensor become disconnected (open circuit) the over red LED flashes, the over relay de-energises and the crank and under relays energise (crank and under LED's illuminate).

### Characteristics

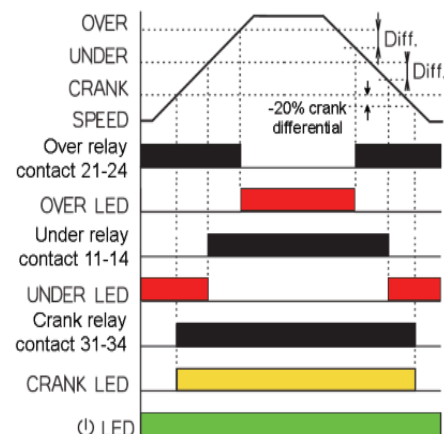

# Speed Sensing

Technical parameters	PH3-12/24
Magnetic pick-up	•
System type	Speed sensing
Supply terminals	AUX (+/-)
Sensor terminals	PULSE IN (+/-)
Supply voltage	12-24V DC
Supply voltage burden (max)	2.5VA/1.4W
Supply voltage tolerance	+20/-10%
Input pulse amplitude	5-75V p-p
Frequency range	0-1kHz min, 0-10kHz max
Trip settings:	
Cranking	10-50%
Under-speed	50-100%
Over-speed	100-130%
Differential	Fixed at 2%
Analogue (meter) output	0-1 mA
at 100% rated speed	0.75 mA
at 133% rated speed	1.0 mA
Output relay-contact; for general switching operation	3x change over (AgNi) plated, volt-free
Output relay-contact terminals	11, 12, & 14, 21, 22 & 24, 31, 32 & 34
Load capability of relay contact AC	250V/8A, max.2 KVA
Load capability of relay contact DC	30V 8A
Mechanical life	3x10 <sup>6</sup> by rated load
ANSI no.	12/14
Operating temperature	-20 +55°C
Storage temperature	-30 +70°C
Electric strength (supplying -contact relay)	4kV/1min.
Overvoltage category	III.
Pollution degree	2
Enclosure integrity	IP40 from the front panel/IP20 terminals
Enclosure style	DIN-rail, 3 module
Case material	Flame retardant polycarbonate
Connecting conductors profile (mm <sup>2</sup> )	Max 2x1.5mm <sup>2</sup> /1x2.5mm <sup>2</sup>
Dimensions	90x52x64mm
Weight	145g approx
Standards	EN 60255-6, EN 60255-27, EN61000-6-2, EN6100-6-4

## Protector Overview PH3

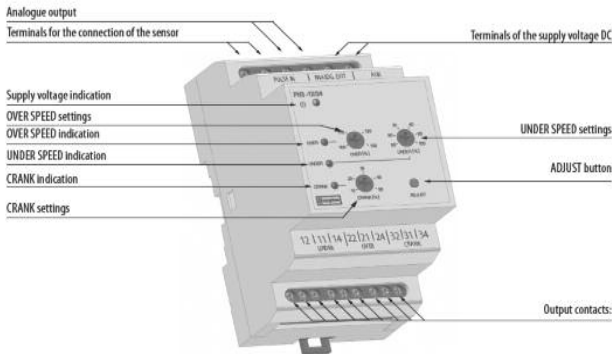

## Connection PH3

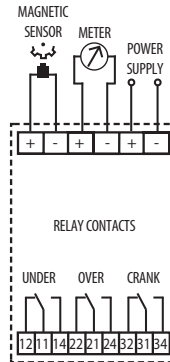

# 373-ELR Earth Leakage Protection Relay

Residual current devices are used to detect dangerous ground fault currents before damage is caused to expensive power assets. The 373-ELR monitors the earth leakage current and compares it with the user selectable trip level. Should this level be exceeded, the relay will trip and with a response time of under 40ms, the supply can be disconnected before serious damage can occur.

## Description

The 373-ELR range offers a standard DPCO version, incorporating a single set point, LED leakage level indicator and double-pole change over relay contacts. For additional functionality, an optional pre-alarm version is available where the main set point relay has two single-pole change-over contacts, one which will de-energise on trip function and the other at 60% of the selected setting. This protector does not check the continuity of any part of the earthing circuit. It is designed for secondary protection due to the externally connected current transformer and contactor components. Life protection devices require an integral CT and mains contactor.

## Operation

The 373-ELR features two incremental rotary selector switches on the front panel and a series of LED annunciators. The trip current switch offers selectable settings from 30mA to 10 amps and the time delay switch offers additional delay for fault discrimination, selectable from 0 to 10 seconds. When the 30mA trip current leakage is selected, the time delay is disabled. Once selections have been made, a green LED indicates mains healthy supply. If the pre-set leakage level is exceeded, the red LED will automatically illuminate, after any selected time delay.

The unit also incorporates five yellow LEDs to indicate the level of leakage in 20% increments. With all five LEDs lit, the leakage level has reached 100% of the setting. The enhanced pre-alarm version also incorporates a red LED providing indication that the level of leakage has reached 60% of the selected range and that the pre-alarm relay has operated. The unit features a combined reset and test button. A short press of the button will reset the unit after a trip and one long press initiates an electronic confidence check. The relay latches on to a fault until the test/reset button is pressed or the auxiliary power is removed. The relay will de-energise on trip (fail safe) as standard. Fitting a link between two terminals will select energise on trip.

## Analogue Outputs

The 373-ELR unit incorporates a 0/1mA analogue output which equals 0% to 100% of the selected tripping level. It can be used to drive an external meter, thus providing measurements for test commissioning and indication of potential problems. The analogue output also enables fault level diagnosis to be communicated into building management or intelligent SCADA systems.

## Core Balanced Current Transformers

The leakage current is determined by passing the phase conductors (and neutral if present) through a core balanced current transformer. The current transformer sums the currents flowing into and back from the load. Ideally, the load will have no leakage current, so current flow through the CT will completely cancel out.

## Dimensions

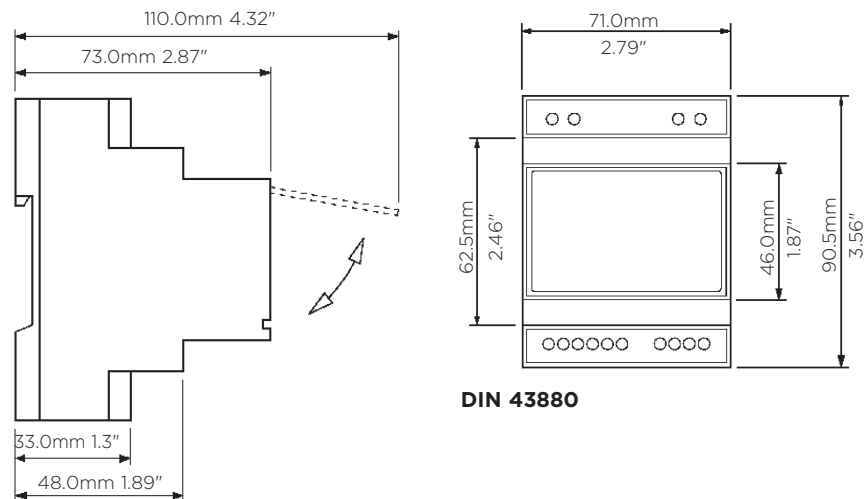

DIN 43880

## Features

- Precision digital settings
- LED bar graph display 10 selectable trip levels – 30mA to 10A
- 16 selectable time delay – 0ms to 10 seconds
- Less than 40ms response time
- 0-1mA analogue output
- 8 amp 250V rated relay contacts
- User selectable energise or de-energise link
- Double-pole change over relay
- Single-pole pre-alarm option

## Benefits

- DIN-rail 43880 enclosure
- Switched mode supply accepts a wide range of auxiliary voltages
- Detects residual current flow
- Isolation of faulty circuits
- Insulation monitoring
- Advanced warning of faults
- Complementary range of core balanced CTs
- Protection of expensive power assets

## Application

- Switchgear
- Distribution systems
- Generator sets
- Control panels
- Building management
- Utility power monitoring
- Process control
- Motor protection
- Transformer protection

# 373-ELR Earth Leakage Protection Relay

## Specification

Measuring input	From core balanced current transformer
Overload	20 x nominal for 1 second
Frequency	50Hz or 60Hz +/-10%
Auxiliary voltage	12-48V DC, 24-48V AC and DC or 100-250V AC and DC
Auxiliary burden	Less than 1.5 Watts
Trip current settings	Selectable 30mA, 100mA, 200mA, 300mA, 500mA, 1A, 2A, 3A, 5A, 10A
Trip accuracy	50% <trip point current <100% in accordance with IEC 1543
Trip response time	<40ms (at 5 x rated trip current, ignoring the selected time delay)
Time delay set points	Selectable 0ms, 50ms, 100ms, 150ms, 200ms, 300ms, 400ms, 500ms, 600ms, 700ms, 800ms, 900ms, 1 second, 2 seconds, 5 seconds, 10 seconds. When 30mA leakage is selected, the time delay is disabled
Indication	5 yellow LED bar graph for leakage levels. Red LED indicated trip function Green LED indicated auxiliary power presence. Red LED pre-alarm indication (SPCO version only)
Relay contacts	Standard: 2-pole change over. Option: 2 1-pole change over (pre-alarm and main alarm)
Relay contact rating	8 amps at 250V AC. 8 amps at 30V DC resistive
Relay mechanical life	>100,000 operations
Analogue output	0 to 1mA = 0 to 100% of selected tripping level. Compliance 1V, accuracy 10%
Enclosure style	DIN 43880, rail width 70mm
Material	Flame retardant UL94V0
Terminals	1 to 4mm <sup>2</sup> solid or stranded conductors. IP20 protection
Operating temperature	-10°C to +60°C
Storage temperature	-20°C to +70°C
Relative humidity	<95% non condensing
Weight	<250g
Dimensions	71mm wide x 90.5mm high x 73mm deep 2.79" wide x 3.56" high x 2.87" deep

## Product Codes - Double-pole Change Over Relay

Relay	Protection	Cat. no.
50Hz	12-48V DC	373-ELRW-CBC5-A1-ST
50Hz	24-48V AC and DC	373-ELRW-CBC5-A2-ST
50Hz	100-250V AC and DC	373-ELRW-CBC5-A3-ST
60Hz	12-48V DC	373-ELRW-CBC6-A1-ST
60Hz	24-48V AC and DC	373-ELRW-CBC6-A2-ST
60Hz	100-250V AC and DC	373-ELRW-CBC6-A3-ST

## Product Codes - Pre-Alarm Single-pole Change Over Relay

Relay	Protection	Cat. no.
50Hz	12-48V DC	373-ELRW-CBC5-A1-PA
50Hz	24-48V AC and DC	373-ELRW-CBC5-A2-PA
50Hz	100-250V AC and DC	373-ELRW-CBC5-A3-PA
60Hz	12-48V DC	373-ELRW-CBC6-A1-PA
60Hz	24-48V AC and DC	373-ELRW-CBC6-A2-PA
60Hz	100-250V AC and DC	373-ELRW-CBC6-A3-PA

## Connections

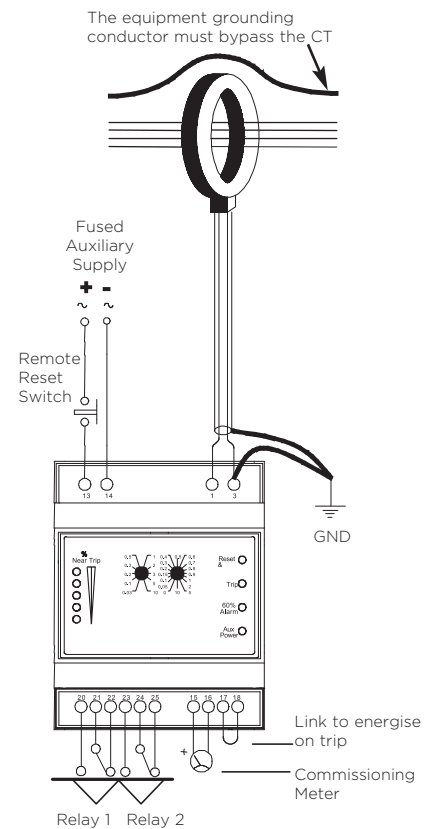

# CBT-94F Core Balanced Current Transformers

The CBT-94F series of core balanced current transformers are exclusively for use with our 373-ELR earth leakage protection relay. The extremely sensitive toroidal core and secondary winding are encapsulated by a self extinguishing case providing excellent mechanical strength, protection from damage and electrical insulation.

## Operation

Primary conductors are grouped together and fed through the transformer aperture. All conductors must pass through the device in the same direction. The current transformers sum the currents flowing into and back from the load. Ideally, the load will have no leakage current, so current flow through the CT will completely cancel out. The equipment grounding conductor must always bypass the current transformer. The connections between the current transformer and protector should be kept as short as possible to minimise signal noise. For best results, use screened cable with the screen grounded at the protector.

## Specification

System voltage	720V maximum
Test voltage	3kV AC for 1 minute
System frequency	50Hz or 60Hz
Primary ratings	From 30mA to 10A
Secondary terminals	Protected to IP20
Operating temperature	-10°C to +50°C
Enclosure	UL94V0 flame retardant plastic
Compliant with	IEC 60044-1, VDE 0414
Mounting hardware	Steel mounting feet for wall or base mounting

## Product Codes

Aperture Dim E	Dim A	Dim B	Dim C	Dim D	Cat no.
35mm	100mm	79mm	26mm	48.5mm	CBT-94F-035
70mm	130mm	110mm	32mm	66mm	CBT-94F-070
105mm	170mm	146mm	38mm	94mm	CBT-94F-105
140mm	220mm	196mm	49mm	123mm	CBT-94F-140
210mm	299mm	284mm	69mm	161mm	CBT-94F-210
300mm	400mm	380mm	-	-	CBT-94F-300

## Dimensions

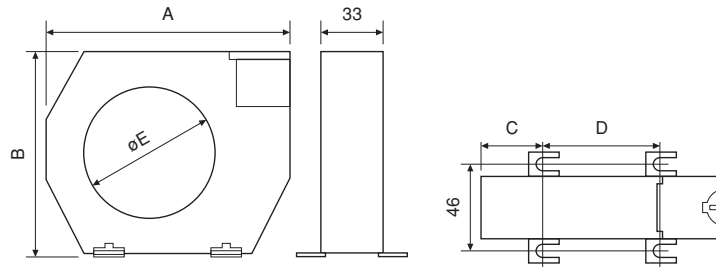

## Features

- Leakage measurement range 0-10 amps
- 6 models available
- Integral wire sealable terminal cover
- Flame retardant high impact moulded case

## Benefits

- Reduction of high currents for ease of metering
- Wide operating temperature -10°C to +50°C
- Steel mounting feet supplied
- Long product life

## Applications

- Switchgear
- Distribution systems
- Generator sets
- Control panels
- Motor protection
- Transformer protection
- Overload protection

## Approvals

- IEC 60044-1



# 373-GFR Ground Fault Relay

The 373-GFR is designed to detect dangerous ground fault currents before damage is caused to expensive power assets. The 373-GFR continuously monitors the fault current and compares it with the user selectable trip level. When this level is exceeded, the relay will trip. With a very fast response time of under 40ms, the supply can be disconnected before serious damage can occur. This product is intended to provide a high degree of ground fault protection and monitoring for any type of electrical equipment, specifically switchboards, generator sets and transformers.

## Operation

The 373-GFR offers a single-pole change over relay contact incorporating a single set point, which will de-energise on trip. The relay senses the ground current by measuring the voltage developed across the N-G link impedance under a fault condition. We offer link selection of two standard N-G impedances, 0.2m ohms or 2m ohms. This is a very cost effective method, since a current transformer is not required. The 373-GFR features two incremental rotary selector switches on the front panel and a series of LED annunciators. The trip current switch offers selectable settings from 100 to 1200 amps and the time delay set point switch offers additional delay for fault discrimination, selectable from 0 to 10 seconds.

Once the trip current and time delay selections have been made, a green LED provides indication of mains healthy supply. The red LED will automatically illuminate if the pre-set fault level has been exceeded, (after any selected time delay). The unit also incorporates five yellow LEDs to indicate the level of leakage in 20% increments. With all five LEDs lit, the leakage level has reached 100% of the setting.

The unit features a combined reset and test button. A short press of the button will reset the unit after a trip and one long press initiates an electronic confidence check. The relay latches on to a fault until the test/reset button is pressed or the auxiliary power is removed. However, automatic reset can be achieved by fitting a wire between two terminals. The relay will de-energise on trip (fail safe) as standard.

## Analogue Outputs

The 373-GFR unit incorporates a 0/1mA analogue output which equals 0% to 100% of the selected tripping level. It can be used to drive an external meter, thus providing measurements for test commissioning and indication of potential problems. The analogue output also enables fault level diagnosis to be communicated into building management or intelligent SCADA systems.

## Product Codes - Single-pole change over relay

Frequency	Auxiliary supply	Cat. no.
50Hz	12-48V DC	373-GFRW-SHC5-A1-SP
50Hz	24-48V AC/DC	373-GFRW-SHC5-A2-SP
50Hz	100-250V AC/DC	373-GFRW-SHC5-A3-SP
60Hz	12-48V DC	373-GFRW-SHC6-A1-SP
60Hz	24-48V AC/DC	373-GFRW-SHC6-A2-SP
60Hz	100-250V AC/DC	373-GFRW-SHC6-A3-SP



## Features

- Precision digital settings
- LED bar graph display
- 10 selectable trip levels - 100 to 1200 amps
- 16 selectable time delay - 0ms to 10 seconds
- Less than 40ms response time
- 0-1mA analogue output
- User selectable input range of 0.2m ohms or 2m ohms
- User selectable latching/self-resetting
- Single-pole change over relay
- 8 amp 250V rated relay contacts

## Benefits

- DIN-rail 43880 enclosure
- Switched mode supply accepts a wide range of auxiliary voltages
- Isolation of faulty circuits
- Insulation monitoring
- Advanced warning of faults
- Protection of expensive power assets
- Current transformer not required

## Applications

- Switchgear
- Distribution systems
- Generator sets
- Control panels
- Utility power monitoring
- Transformer protection

# 373-GFR Ground Fault Relay

## Specifications

Measuring input	AC voltage developed across N-G link
Measuring range	0.2 mΩ or 2 mΩ shunt impedance link selectable
Overload	Maximum input voltage 600V
Frequency	50/60Hz
Auxiliary voltage	12-48V DC, 24-48V AC and DC or 100-250V AC and DC
Auxiliary burden	Less than 1.5 Watts
Trip current settings	Selectable 100A, 150A, 200A, 250A, 300A, 450A, 600A, 750A, 800A, 1200A
Trip accuracy	50% <trip point current ≤100% in accordance with IEC 1543
Trip response time	<40ms (at 5 x rated trip current, ignoring the selected time delay)
Time delay set points	Selectable 0ms, 50ms, 100ms, 150ms, 200ms, 300ms, 400ms, 500ms, 600ms, 700ms, 800ms, 900ms. 1 second, 2 seconds, 5 seconds, 10 seconds.
Indication	5 yellow LED bar graph for fault levels. Red LED indicated trip function Green LED indicated auxiliary power presence
Relay contacts	1-pole change over (SPCO or NO+NC) contacts
Relay contact rating	8 amps at 250V AC. 8 amps at 30V DC resistive
Relay mechanical life	>100,000 operations
Analogue output	0 to 1 mA = 0 to 100% of selected tripping level. Compliance 1V, accuracy 10%
Enclosure style	DIN 43880, rail width 70mm
Material	Flame retardant UL94V0
Terminals	1 to 4mm <sup>2</sup> solid or stranded conductors. IP20 protection
Operating temperature	-10°C to +60°C
Storage temperature	-20°C to +70°C
Relative humidity	<95% non condensing
Weight	<250g
Dimensions	71mm widex90.5mm highx73mm deep 2.79" widex3.56" highx2.87" deep

## Dimensions

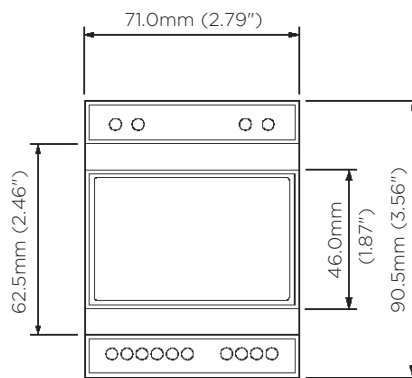
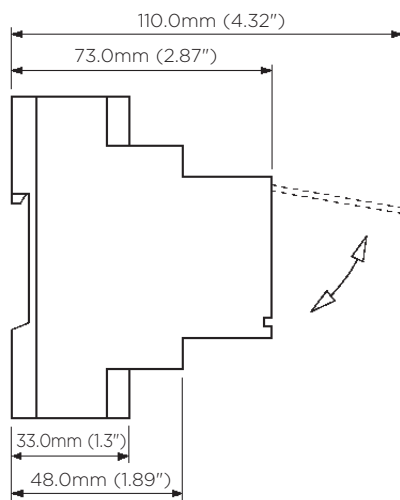

DIN 43880

## Connections

Install the neutral to ground shunt resistor in a suitable location. Connect the shunt sense wires directly to terminals N (neutral side) and G (ground side) on the relay. Cabling between the shunt resistor and the ground fault relay should be kept to a minimum.

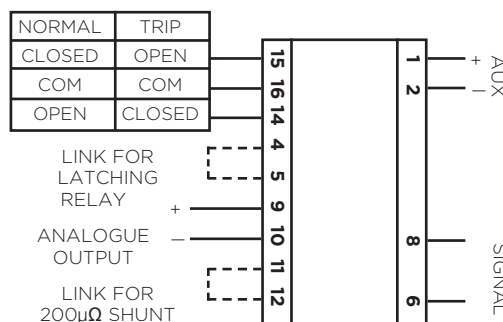

## Terminal No.

- 8 Neutral input
- 6 Ground input
- 2 Fused auxiliary supply (-)
- 1 Fused auxiliary supply (+)
- 4 Default operation is non-latching
- 5 Fit link to enable relay latch on trip
- 9/10 Analogue output 0/1mA
- 11 Default input range is for 2 mΩ shunt
- 12 Link to select 200μΩ shunt input
- 14 Relay (NO)
- 15 Relay (COM)
- 16 Relay (NC)

# Part Numbers

Part number	Protection	System	Page
<b>AC current with adjustable time delay</b>			<b>2-5</b>
PAU-1	Under current	Single-phase, 1A AC, 50/60Hz, Aux 24/240V AC/DC	
PAU-5	Under current	Single-phase, 5A AC, 50/60Hz, Aux 24/240V AC/DC	
PAO-1	Over current	Single-phase, 1A AC, 50/60Hz, Aux 24/240V AC/DC	
PAO-5	Over current	Single-phase, 5A AC, 50/60Hz, Aux 24/240V AC/DC	
PAD-1	Under/over current (2 output relays)	Single-phase, 1A AC, 50/60Hz, Aux 24/240V AC/DC	
PAD-5	Under/over current (2 output relays)	Single-phase, 5A AC, 50/60Hz, Aux 24/240V AC/DC	
PAP/V-1	Under/over current (2 output relays)	3-phase, 3 or 4-wire, 1A AC, 50/60Hz, Aux 24/240V AC/DC	
PAP/V-5	Under/over current (2 output relays)	3-phase, 3 or 4-wire, 5A AC, 50/60Hz, Aux 24/240V AC/DC	
<b>AC voltage with adjustable differential and time delay</b>			<b>6-11</b>
PVU/Z-100/120	Under voltage	Single-phase, 57.7/69.3V L-N AC, 50/60Hz	
PVU/Z-173/240	Under voltage	Single-phase, 100/139V L-N AC, 50/60Hz	
PVU/Z-380/480	Under voltage	Single-phase, 220/277V L-N AC, 50/60Hz	
PVO/H-100/120	Over voltage	Single-phase, 57.7/69.3V L-N AC, 50/60Hz	
PVO/H-173/240	Over voltage	Single-phase, 100/139V L-N AC, 50/60Hz	
PVO/H-380/480	Over voltage	Single-phase, 220/277V L-N AC, 50/60Hz	
PVB-100/120	Under/over voltage (2 output relays)	Single-phase, 57.7/69.3V L-N AC, 50/60Hz	
PVB-173/240	Under/over voltage (2 output relays)	Single-phase, 100/139V L-N AC, 50/60Hz	
PVB-380/480	Under/over voltage (2 output relays)	Single-phase, 220/277V L-N AC, 50/60Hz	
PVK/J-100/120	Under voltage	3-phase 3-wire, 100/120V L-L AC, 50/60Hz	
PVK/J-173/240	Under voltage	3-phase 3-wire, 173/240V L-L AC, 50/60Hz	
PVK/J-380/480	Under voltage (2 output relays)	3-phase 3-wire, 380/480V L-L AC, 50/60Hz	
PVA/C-100/120	Over voltage	3-phase 3-wire, 100/120V L-L AC, 50/60Hz	
PVA/C-173/240	Over voltage	3-phase 3-wire, 173/240V L-L AC, 50/60Hz	
PVA/C-380/480	Over voltage (2 output relays)	3-phase 3-wire, 380/480V L-L AC, 50/60Hz	
PVM-100/120	Under/over voltage (2 output relays)	3-phase 3-wire, 100/120V L-L AC, 50/60Hz	
PVM-173/240	Under/over voltage (2 output relays)	3-phase 3-wire, 173/240V L-L AC, 50/60Hz	
PVM-380/480	Under/over voltage (2 output relays)	3-phase 3-wire, 380/480V L-L AC, 50/60Hz	
PVV/X-100/120	Under voltage	3-phase 4-wire, 57.7/69.3V L-N (100/120V L-L) AC, 50/60Hz	
PVV/X-173/240	Under voltage	3-phase 4-wire, 100/139V L-N (173/240V L-L) AC, 50/60Hz	
PVV/X-380/480	Under voltage (2 output relays)	3-phase 4-wire, 220/277V L-N (380/480V L-L) AC, 50/60Hz	
PVP/S-100/120	Over voltage	3-phase 4-wire, 57.7/69.3V L-N (100/120V L-L) AC, 50/60Hz	
PVP/S-173/240	Over voltage	3-phase 4-wire, 100/139V L-N (173/240V L-L) AC, 50/60Hz	
PVP/S-380/480	Over voltage (2 output relays)	3-phase 4-wire, 220/277V L-N (380/480V L-L) AC, 50/60Hz	
PVE-100/120	Under/over voltage (2 output relays)	3-phase 4-wire, 57.7/69.3V L-N (100/120V L-L) AC, 50/60Hz	
PVE 173/240	Under/over voltage (2 output relays)	3-phase 4-wire, 100/139V L-N (173/240V L-L) AC, 50/60Hz	
PVE-380/480	Under/over voltage (2 output relays)	3-phase 4-wire, 220/277V L-N (380/480V L-L) AC, 50/60Hz	
<b>Frequency with adjustable differential and time delay</b>			<b>12-13</b>
PHD-100/120	Under/over frequency (2 relays)	Single-phase, 57.7/69.3V L-N AC (50, 60 and 400Hz)	
PHD-173/240	Under/over frequency (2 relays)	Single-phase, 100/139V L-N AC (50, 60 and 400Hz)	
PHD-380/480	Under/over frequency (2 relays)	Single-phase, 220/277V L-N AC (50, 60 and 400Hz)	
<b>Phase sequence and phase failure</b>			<b>14-15</b>
PVR3-100/120	Phase sequence under voltage	3-phase 3-wire, 100/120V L-L AC, 50/60Hz	
PVR3-173/240	Phase sequence under voltage	3-phase 3-wire, 173/240V L-L AC, 50/60Hz	
PVR3-380/480	Phase sequence under voltage (2 output relays)	3-phase 3-wire, 380/480V L-L AC, 50/60Hz	
PVR4-100/120	Phase sequence under voltage	3-phase 3-wire, 100/120V L-L AC, 50/60Hz	
PVR4-173/240	Phase sequence under voltage	3-phase 3-wire, 173/240V L-L AC, 50/60Hz	
PVR4-380/480	Phase sequence under voltage (2 output relays)	3-phase 3-wire, 380/480V L-L AC, 50/60Hz	
<b>Phase balance and under relay with adjustable time delay and unbalance</b>			<b>16-17</b>
PSF/G3-100/120	Phase loss, unbalanced and under voltage	3-phase 3-wire, 100/120V L-L AC, 50/60Hz	
PSF/G3-173/240	Phase loss, unbalanced and under voltage	3-phase 3-wire, 173/240V L-L AC, 50/60Hz	
PSF/G3-380/480	Phase loss, unbalanced and under voltage	3-phase 3-wire, 380/480V L-L AC, 50/60Hz	
PSF/G4-100/120	Phase loss, unbalanced and under voltage	3-phase 4-wire, 57.7/69.3V L-N (100/120V L-L) AC, 50/60Hz	
PSF/G4-173/240	Phase loss, unbalanced and under voltage	3-phase 4-wire, 100/139V L-N (173/240V L-L) AC, 50/60Hz	
PSF/G4-380/480	Phase loss, unbalanced and under voltage	3-phase 4-wire, 220/277V L-N (380/480V L-L) AC, 50/60Hz	
<b>Reverse power (current) with adjustable time delay</b>			<b>20-21</b>
PAS-100/120	Reverse power	Single or 3-phase, 4-wire, 57.7/69.3V L-N (100/120V L-L) AC, 0-6A AC, 50/60Hz	
PAS-173/240	Reverse power	Single or 3-phase, 4-wire, 100/139V L-N (173/240V L-L) AC, 0-6A AC, 50/60Hz	
PAS-380/480	Reverse power	Single or 3-phase, 4-wire, 220/277V L-N (380/480V L-L) AC, 0-6A AC, 50/60Hz	
PAT-100/120	Reverse power	3-phase, 3-wire, 100-120V AC, 0-6A AC, 50/60Hz	
PAT-173/240	Reverse power	3-phase, 3-wire, 173-240V AC, 0-6A AC, 50/60Hz	
PAT-380/480	Reverse power	3-phase, 3-wire, 380-480V AC, 0-6A AC, 50/60Hz	
<b>Syncro-check with dead bus facility</b>			<b>18-19</b>
PLL/D-100/120	Phase angle and voltage dead bus	Single or 3-phase, 4-wire, 57.7/69.3V L-N AC, 50/60Hz	
PLL/D-173/240	Phase angle and voltage dead bus	Single or 3-phase, 4-wire, 100/139V L-N AC, 50/60Hz	
PLL/D-380/480	Phase angle and voltage dead bus	Single or 3-phase, 4-wire, 220/277V L-N AC, 50/60Hz	
<b>Thermistor trip with over trip relay and manual/remote reset</b>			<b>24-25</b>
PMM/T-24/240	Over temperature	Input PTC thermistors, 24/240V AC/DC Aux	
<b>DC Millivolts with adjustable time delay</b>			<b>22-23</b>
PBT/S-24/240	High/low trip (2 output relays)	50, 75, 100mV DC, 24/240V AC/DC Aux	
PBT/S-12/24	High/low trip (2 output relays)	50, 75, 100mV DC, 12/24V DC Aux	
<b>DC Milliamps with adjustable time delay</b>			<b>22-23</b>
PBV-24/240	High/low trip (2 output relays)	0/1, 0/10, 0/20, 4/20mA DC, 24/240V AC/DC Aux	
PBV-12/24	High/low trip (2 output relays)	0/1, 0/10, 0/20, 4/20mA DC, 12/24V DC Aux	
<b>Speed sensing</b>			<b>26-27</b>
PH3-12/24	3 Setpoints, 1 relay	Input. Magnetic pickup, 12/24V DC Aux	

## About TE Connectivity

TE Connectivity is a global, \$14 billion company that designs and manufactures over 500,000 products that connect and protect the flow of power and data inside the products that touch every aspect of our lives. Our nearly 100,000 employees partner with customers in virtually every industry – from consumer electronics, energy and healthcare, to automotive, aerospace and communication networks – enabling smarter, faster, better technologies to connect products to possibilities.

While TE Connectivity (TE) has made every reasonable effort to ensure the accuracy of the information in this catalogue, TE does not guarantee that it is error-free, nor does TE make any other representation, warranty or guarantee that the information is accurate, correct, reliable or current. TE reserves the right to make any adjustments to the information contained herein at any time without notice. TE expressly disclaims all implied warranties regarding the information contained herein, including, but not limited to, any implied warranties of merchantability or fitness for a particular purpose. The dimensions in this catalogue are for reference purposes only and are subject to change without notice. Specifications are subject to change without notice. Consult TE for the latest dimensions and design specifications. TE Connectivity and TE Connectivity (logo) are trademarks. Crompton is a trademark of Crompton Parkinson and is used by TE Connectivity under a licence. Other trademarks are property of their respective owners.

**TE Energy – innovative and economical solutions for the electrical power industry: cable accessories, connectors & fittings, insulators & insulation, surge arresters, switching equipment, street lighting, power measurement and control.**

**Tyco Electronics UK Ltd**  
TE Connectivity Company  
Freebournes Road  
Witham, Essex CM8 3AH

**Registered office:**  
Faraday Road, Dorcan  
Swindon, SN3 5HH  
Reg. no. 550 926

Phone: +44 (0)870 870 7500  
Fax: +44 (0)870 240 5287  
Email: [crompton.info@te.com](mailto:crompton.info@te.com)

[www.crompton-instruments.com](http://www.crompton-instruments.com)  
<http://energy.te.com>

