











# TABLE OF CONTENTS

## IEC-309-1 and IEC-309-2 Pin and Sleeve Devices

	Introduction .....	2-5
	Material Specifications .....	6-7
	North American Ratings (20 to 100 Amp).....	8-16
	Accessories .....	17-18
	International Ratings (16 to 125 Amp).....	19-28
	New Products.....	29-31
	Light & Stage.....	32-33
	Specialty Products .....	34-35
	Useful Tables .....	36-37
	Drawings and Dimensions.....	38-47

## IEC-309-1 and IEC-309-2 Mechanical Interlocks

	Introduction .....	48-49
	North American Ratings (20 to 100 Amp)....	50-55
	International Ratings (16 to 125 Amp).....	56-60

## Manual Disconnect Switches

	Manual Disconnect Switches .....	61-69
-------------------------------------------------------------------------------------	----------------------------------	-------

## Custom-Built Power Distribution Systems

	Custom-Built Power Distribution Systems.....	70-77
-------------------------------------------------------------------------------------	----------------------------------------------	-------



## WORLDWIDE INTERCHANGEABILITY

Walther's pin & sleeve devices are built to IEC 309-1 and 309-2 specifications and are interchangeable with other manufacturers who conform to these IEC standards and color coding system... anywhere in the world. Manufacturers that do not comply with these standards have their own proprietary configurations and are not plug compatible with other pin & sleeve products. Once you have selected a proprietary configuration you are locked in to a single source. Specifying IEC 309-1 & 309-2 devices provides convenience and flexibility that users have come to accept almost without thinking.

## SAFETY

IEC 309-2 configurations for plugs (or inlets) and receptacles (or connectors) are single-rated which assures proper mating of devices with the same voltage and amperage. It is virtually impossible to couple a plug and receptacle of different voltage and /or amperage ratings.

The size of the device is determined by the amperage rating. Plugs and receptacles of different amperage ratings are not compatible because of the size variance.

Many proprietary pin & sleeve configurations, that do not conform to the IEC standards, are designed to accommodate multiple voltage systems. A plug wired to a piece of equipment designed to operate at one voltage system could unintentionally be plugged into a receptacle wired with an unlike voltage. Mismatching voltages could cause damage to the equipment or even personal injury and is not considered safe electrical practice.

The voltage, of single rated Pin & Sleeve devices of the IEC 309-2 type, is determined by the location of the oversized female ground contact relative to the key-way located at the bottom of the housing. A clock face is used to represent the location of the ground sleeve for a specific voltage system. For example, a 480 VAC receptacle will have the oversized ground sleeve located in the 7 o'clock position. The corresponding grounding pin location on the plug or inlet is a mirror image of the female device. Devices of mismatched voltage systems simply cannot be mated. Each device is clearly marked with the voltage system for which it is intended to be used. The diagram below shows the keying position and the color coding that is associated with each voltage system.

Walther CEETyp Female Ground Clockface Positions in Accordance with IEC 309-2 and UL 1686

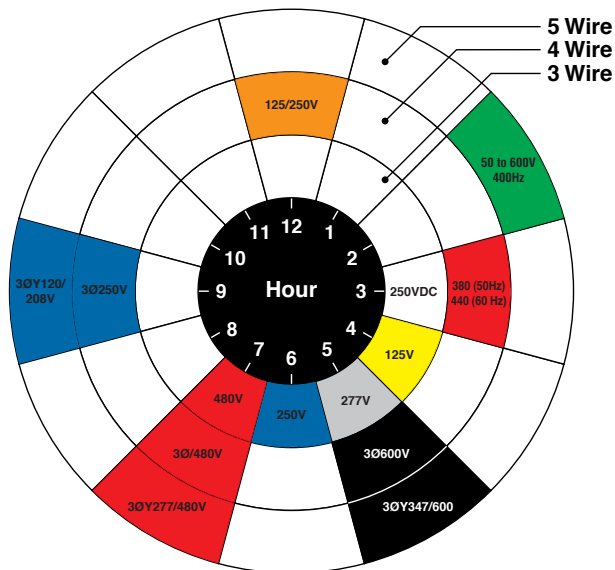

North American Rating  
Voltage AC (Except where noted)

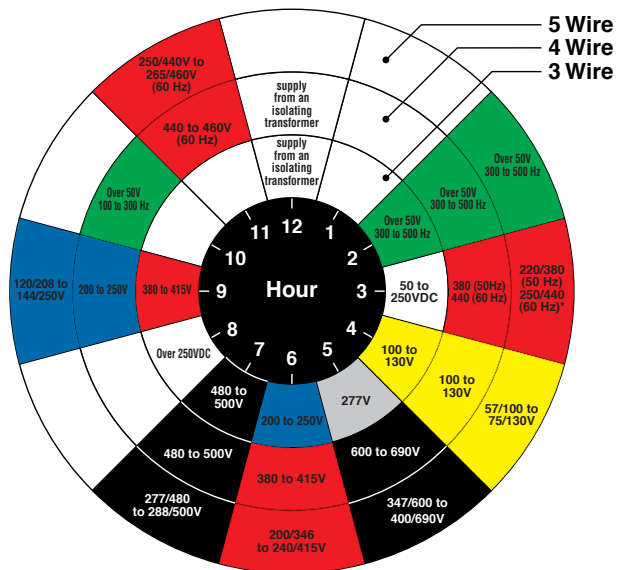

International Rating  
Voltage AC (Except where noted)

The insulated housing is made from a high impact, nylon material. The nonmetallic device, while abuse and corrosion resistant, is also nonconductive, which enhances the safety of the product.

## ELECTRICAL INTERLOCK

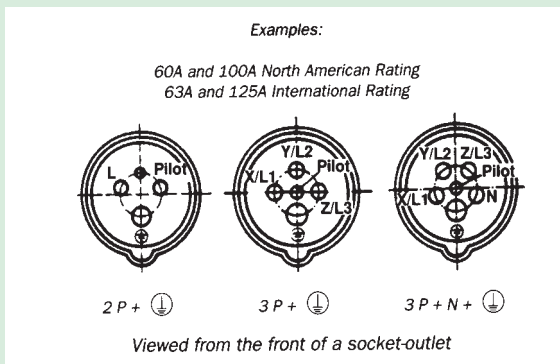

Plugs and receptacles rated 60 amps and above, feature an "electrical interlock" by way of a pilot pin on the plug and female sleeve on the receptacle that is shorter than the main pins. The pilot pin and female sleeve make contact last, and break contact first. This sequence turns the power on when the pilot pin and sleeve mate, and turns the power off before the phase contacts are disengaged. This prevents making or breaking the circuit under load.

## RELIABILITY

Walther offers the widest variety of plugs, receptacles, connectors and inlets, made of the highest quality and design integrity in both splashproof and watertight versions.

Watertight (IP67) devices are designed for use in the most demanding environments that require safety, ease of use, reliability and durability. These devices can withstand impact and vibration and provide complete protection against dirt, dust, water jets and even temporary flooding. Watertight devices are available in 20, 30, 60 and 100 amp (North American) ratings and 16, 32, 63 and 125 amp (International) ratings.

Splashproof (IP44) devices are suitable and recommended for use in a variety of light industrial environments and provide complete protection against contact with live parts, damaging

deposits of dirt and dust and splashing water. Splashproof devices provide many of the heavy duty construction features found in the watertight products, but at a more economical cost. Splashproof devices are available in 20, 30 and 60 amp (North American) ratings and 16, 32 and 63 amp (International) ratings.

Watertight and splashproof devices provide exceptional UV stability for superior outdoor performance.

All Walther plugs and connectors are supplied with an internal cord clamp designed to firmly grip not only the outer cable jacket but also the internal conductors. The internal cord clamp eliminates strain on the terminals while providing high pull-out values without external protrusions to snag adjacent wiring or the installer.

In addition to the internal cord clamp, Watertight plugs and connectors are also supplied with an external cable gland. This cable gland serves as a secondary method of eliminating strain on the terminals and conductors while assuring watertight performance. Standard splashproof plugs and connectors are also supplied with the same external gland as the watertight devices. However, a cable sleeve, designed to speedup installation, is provided with a lower cost splashproof alternative.

All Walther plugs and connectors, furnished with either a cable gland or cable sleeve, meet the cord and cable secureness requirements defined in UL 1682, Section 33.

**TABLE 1 - CHARACTERISTICS DEFINED BY THE CEI 70-1 - IEC 529 - IEC 144 - UTE C 20-010 - DIN 40050 STANDARDS**

First Digit - Protection against persons - touching and ingress of solid foreign objects			Second Digit - Protection against the penetration of liquids								
			IP_0	IP_1	IP_2	IP_3	IP_4	IP_5	IP_6	IP_7	IP_8
Non protected											
IP 0_		Without protection	IP 00								
IP 1_		Protection against touching with the hand and solid objects greater than 50mm dia.	IP 10	IP 11	IP 12						
IP 2_		Protection against touching with the finger and solid objects greater than 12mm dia.	IP 20	IP 21	IP 22	IP 23					
IP 3_		Protection against touching with tools, wires, etc. more than 2.5mm thick and solid objects greater than 2.5mm dia.	IP 30	IP 31	IP 32	IP 33	IP 34				
IP 4_		Protection against touching with tools, wires, etc. more than 1mm thick and solid objects greater than 1mm dia.	IP 40	IP 41	IP 42	IP 43	IP 44				
IP 5_		Unlimited protection against contact with live parts and damaging deposits of dust	IP 50				IP 54	IP 55			
IP 6_		Unlimited protection against contact with live parts and any penetration of dust	IP 60					IP 65	IP 66	IP 67	IP 68

In some countries a third digit (for mechanical security) is added.

**TABLE 2**

Designation	Intended Use and Description	Construction Requirements
3	Outdoor use primarily to provide a degree of protection against rain, sleet, windblown dust and damage from external ice formation.	Splashproof (IP44)
4	Indoor and outdoor use primarily to provide a degree of protection against windblown dust and rain, splashing water, hose-directed water and damage from external ice formation.	Watertight (IP67)
4X	Indoor and outdoor use primarily to provide a degree of protection against corrosion, windblown dust and rain, splashing water, hose-directed water and damage from external ice formation.	Watertight (IP67)
6	Indoor and outdoor use primarily to provide a degree of protection against hose-directed water, and the entry of water during occasional temporary submersion at a limited depth and damage from external ice formation.	Watertight (IP67)
12, 12K	Indoor use primarily to provide a degree of protection against circulating dust, falling dirt, and dripping non-corrosive liquids.	Splashproof (IP44)

This information is provided only as a general guide. No specific recommendation is intended. As each application may vary, testing should be conducted by the user in the intended environment.

# IEC 309 PIN AND SLEEVE DEVICES

**Retaining Device**  
Holds the plug in position when it is in proper engagement with a connector or socket-outlet and prevents its unintentional withdraw

**Internal Strain Relief with "Swing-Away" Feature**  
Designed to firmly grip not only the outer cable jacket but also the internal conductors. Eliminates strain on the terminals while providing high pull-out values. "Swing-Away" feature provides easy access to terminal screws. Reliability! Ease of Use!

**Shrouded Pins**  
Pins are recessed in the nylon housing and protected from deforming due to physical abuse. Eliminates the potential hazard of touching the live contacts while the plug is partially engaged. Safety! Reliability!

**External Cable Gland with "Onion Ring" Neoprene Bushing**  
The compression type cable gland serves as a secondary method of eliminating strain on the terminals and conductors while assuring watertight performance. Accommodates various cable sizes. Reliability! Ease of Use!

**Electro Zinc Plated Steel Screws**  
Corrosion resistant. Captive no loose parts to handle or misplace. Durability! Ease of Use!

**Locking Ring and Gasket**  
Protects against intrusion of dirt, dust and moisture when the male and female devices are connected. Reliability!

**Terminal Identification**  
Ground, neutral and phase terminals are clearly identified for easy recognition and ease of wiring.

**Color Coded**  
Avoid mismatching. Prevents confusion with regards to voltage ratings. Safety! Ease of Use!

**Spring Loaded Gasketed Covers**  
Protects against accidental encounter with live contacts. Also, protects against intrusion of dirt, dust and moisture. A bayonet coupling device is used to provide optimum stability an simplify installation. Reliability! Safety!

**High Impact Thermoplastic Housing**  
The nonmetallic device, while abuse and corrosion resistant, is also nonconductive, which enhances the safety of the product. The insulated housing is made from a high impact, nylon material and is UV stabilized. Safety! Durability

**Staggered Contacts**  
Oversized ground contact is farthest forward, assuring first make and last break. Neutral is next to prevent the possibility of an "open neutral" condition. Phase contact is farthest making it last to make, first to break. Safety!

**Recessed Contacts**  
Contact sleeves are recessed in the narrow contact tubes thus, providing a "finger proof" device and protecting against any accidental encounter with live contacts. Safety!

**Retaining Device**  
Walther pin & sleeve devices are provided with a mechanical arrangement which holds a plug or connector in position when it is in proper engagement, and prevents its unintentional withdraw.

**Double Terminal Screws**  
Maximum clamping pressure without damaging strands. Double terminal screws create a large area of safe and secure contact between conductor and terminal. Screws are captive, easily accessible and supplied in the open position. Reliability! Safety!

**Solid Brass Pins**  
Low contact resistance and high conductivity. Long lasting, reliable electrical contact. Reliability!

**Split Contact Sleeve with Nickel Plated Steel Springs**  
Provides optimum insertion/withdraw force and constant contact pressure Reliability!

**Chamfered Terminals**  
Funnel Entry. Guides and captures all wire strands. Ease of Use! Reliability!

## PLUG

Assembly Screws*	Steel, Electro Zinc Plated
Friction Ring*	Steel, Electro Zinc Plated
Gland Cap	Polycarbonate Blend
Grommet	Solid Neoprene
Housing (Front and Back)	Type 6 Nylon
Internal Cord Clamp	Type 6 Nylon
Locking Ring	Type 6 Nylon
Pins (Watertight)	Brass, Nickel Plated
Pins (Splashproof)	Brass
Sealing Gasket	Neoprene
Terminal Screws	Steel, Nickel Plated

## INLET

Housing	Type 6 Nylon
Locking Ring	Type 6 Nylon
Mounting Flange	Type 6 Nylon
Pins (Watertight)	Brass, Nickel Plated
Pins (Splashproof)	Brass
Sealing Gasket	Neoprene
Terminal Screws	Steel, Nickel Plated

\* Stainless steel available upon request

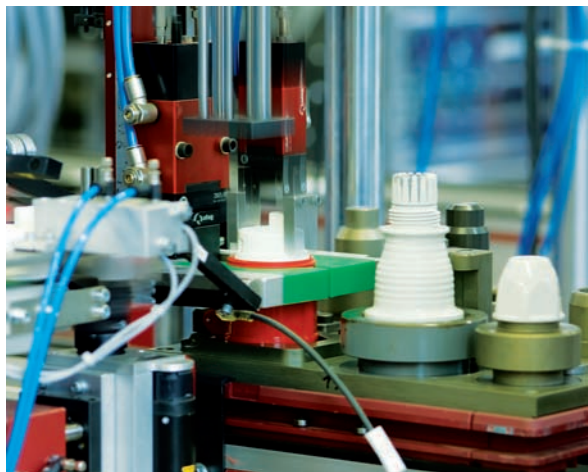

## CONNECTOR

Assembly Screws*	Steel, Electro Zinc Plated
Cover	Type 6 Nylon
Cover Fastener	Nickel Plated Brass, Brass or Macrolon
Cover Spring	Stainless Steel (A2)
Friction Ring*	Steel, Electro Zinc Plated
Gland Cap	Polycarbonate Blend
Grommet	Solid Neoprene
Housing (Front and Back)	Type 6 Nylon
Internal Cord Clamp	Type 6 Nylon
Sealing Gasket	Neoprene
Sleeve Spring	Steel, Nickel Plated
Sleeves (Watertight)	Brass, Nickel Plated
Sleeves (Splashproof)	Brass
Terminal Screws	Steel, Nickel Plated

## RECEPTACLE

Cover	Type 6 Nylon
Cover Fastener	Nickel Plated Brass, Brass or Macrolon
Cover Spring	Stainless Steel (A2)
Housing	Type 6 Nylon
Mounting Flange	Type 6 Nylon
Sealing Gasket	Neoprene
Sleeve Spring	Steel, Nickel Plated
Sleeves (Watertight)	Brass, Nickel Plated
Sleeves (Splashproof)	Brass
Terminal Screws	Steel, Nickel Plated

Manufacturing pin & sleeve devices, of superior quality, can only be accomplished through the use of high grade materials. That is an important part of the Walther Pin & Sleeve system — quality products you can depend on.

Male pins and female sleeves are made of high conductivity brass. Contacts used with watertight devices are nickel plated to prevent corrosion. The insulated housing is made from a high impact, nylon material. The nonmetallic device, while resistant to most solvents, chemicals and salt water, is also non-conductive, which enhances the safety of the product.

All extracts from manufacturing, test standard or independent agency approvals is for informational purposes only and are not intended to be, should not be used as, nor considered to be a complete description of such. Contact customer service for a more complete version of the test standard or agency approval in question.

Walther reserves the right to make technical descriptive and dimensional changes due to product changes and/or improvements.

## Minimum test requirements

## ELECTRICAL

<b>Insulation Resistance</b>	500V for 1 min. Resistance $\geq 5M \Omega$
<b>Dielectric Voltage Withstand</b>	3000V for 1 min.
<b>Ground Path Current</b>	See Table 1
<b>Endurance, Connect and Disconnect Cycles</b>	See Table 2
<b>Current Interrupting</b>	Certified for current interrupting at full rated current and voltage.
<b>Overload Test</b> (Power factor 0.75 - 0.80)	Tested for current interrupting at 150% of the rated current and 100% of the rated voltage for 50 cycles.
<b>Temperature Rise</b>	Maximum 30° C rise at full rated current (after overload).
<b>Resistance to Arcing</b>	Continuation of overload test for an additional 200 cycles.

## MECHANICAL

<b>Mold Stress Relief</b>	70°C (158°F) for 7 hours.
<b>Humidity</b>	32°C (89.6°F), 93% humidity for 7 days (168 hours).
<b>Cable Secureness</b>	See Table 3
<b>Impact</b>	A device is wired with a 90" (2300mm) length of flexible cord and dropped from 30" (760mm) 8 times. The device is then conditioned for 6 hours at -25°C and immediately subjected to a repeated impact test.
<b>Crushing</b>	250 lbs for 1 minute. The device is then conditioned for 6 hours at -25°C and immediately subjected to a repeated crushing test.
<b>Withdrawal Force</b>	See Table 4
<b>Strength of Insulating Base and Support</b>	110% of specified tightening torque on terminal screws.
<b>Polarization Integrity</b>	Matching devices will not mate so that the ground is energized, even when polarization feature is removed and 40 lb (180 N) insertion force is applied.

## ENVIRONMENTAL

<b>Flammability</b>	V-2 or better per UL 94 or CSA 22.2 No. 0.6
<b>Ambient Temperature Range</b>	Minimum: -25°C (-13°F) with impact Maximum: 90°C (194°F)
<b>Resistance to Corrosion</b>	Ferrous parts immersed for 10 min. in a 10% solution of ammonium chloride at a temperature of 20°C.
<b>Moisture Resistance</b>	Watertight (IP67): Device immersed for 24 hours in water at a temp. of 25°C, the highest point of the device being 2" (5cm) below the water level. Splashproof (IP44): Device is sprayed with water for 10 minutes and immediately afterwards subjected to splashing water in all directions (360°).
<b>UV Resistance</b>	Exposed plastic materials are UV stabilized.

TABLE 1

Ground Path Current Test				
Device Rating Amperes	Minimum Size Grounding Conductor		Time, Seconds	Test Current, Amperes
	AWG	mm <sup>2</sup>		
20	12	3.3	4	470
30	10	5.3	4	750
60	10	5.3	4	750
100	8	8.4	4	1180

A test current that far exceeds the device rating, is passed through the mating devices and grounding wires.

TABLE 2

Endurance Test			
Device Rating Amperes	Cycles with Load at Rated Current and Voltage	No-Load Cycles	Sequence
20	5000	0	-
30	1000	1000	Alternating
60	1000	1000	Alternating
100	250	250	Alternating

The test sequence is conducted by using a no-load, followed by a load sequence. The power factor of the load is 0.75 to 0.80.

TABLE 3

Cable Secureness Test						
Device Rating Amperes	Force		Torque		Maximum Displacement	
	lb.	N	ft-lb.	N•m	Inches	mm
20	30	133	0.4	0.54	3/32	2.38
30	75	333	0.5	0.68	3/32	2.38
60	150	667	1.0	1.4	3/32	2.38
100	150	667	2.0	2.7	3/32	2.38

The flexible cord or cable is simultaneously twisted and pulled. Values for the applied twisting torque and force of pull are shown in Table 3. In all cases the cord displacement is less than 3/32 inches.

TABLE 4

Withdrawal Forces Test			
Device Rating Amperes	Minimum Withdrawal Force		
	lb.	N	Time, Minutes
20	5	22	1
30	6	27	1
60	15	67	1
100	20	89	1

The pressure exerted by mating contacts of a plug and connector must be sufficient to prevent unintentional withdrawal during normal use. During the test, any locking rings or retaining means are not to be engaged.







These products are Listed to applicable UL Standards and requirements by Underwriters Laboratories Inc. UL 1682 UL 1686







## MALE PLUGS

  Certified

			WATERTIGHT (IP67)	SPLASHPROOF (IP44)			
				Standard Version (with cable gland)	Economical Version (with cable sleeve)	Low Profile Angled 90°	
Poles and Wires	Voltage AC (Except where noted)	Clock Position of Ground Contact					
<b>3</b>	2P + G	250 DC	3	219315	211315	210315	216315
	1P + N + G	125	4	219316	211316	210316	216316
	2P + G	250	6	219306	211306	210306	216306
	1P + N + G	277	5	219317	211317	210317	216317
	2P + G	480	7	219319	211319	210319	216319
<b>4</b>	2P + N + G	125/250	12	218424	212424	210424	216424
	3P + G	3Ø250	9	218409	212409	210409	216409
	3P + G	3Ø480	7	218419	212419	210419	216419
	3P + G	3Ø600	5	218405	212405	210405	216405
<b>5</b>	3P + N + G	Barge Overflow	1	218501BL			
	3P + N + G	3ØY120/208	9	218509	212509	210509	216509
	3P + N + G	3ØY277/480	7	218519	212519	210519	216519
	3P + N + G	3ØY347/600	5	218505	212505	210505	216505
<b>7</b>	6P + G	250	9		212709	210709	
	6P + G	480	7		212719	210719	

## FEMALE CONNECTORS

  Certified

			WATERTIGHT (IP67)	SPLASHPROOF (IP44)			
				Standard Version (with cable gland)	Economical Version (with cable sleeve)	Low Profile Angled 90°	
Poles and Wires	Voltage AC (Except where noted)	Clock Position of Ground Contact					
<b>3</b>	2P + G	250 DC	3	319315	311315	310315	316315
	1P + N + G	125	4	319316	311316	310316	316316
	2P + G	250	6	319306	311306	310306	316306
	1P + N + G	277	5	319317	311317	310317	316317
	2P + G	480	7	319319	311319	310319	316319
<b>4</b>	2P + N + G	125/250	12	318424	312424	310424	
	3P + G	3Ø250	9	318409	312409	310409	
	3P + G	3Ø480	7	318419	312419	310419	
	3P + G	3Ø600	5	318405	312405	310405	
<b>5</b>	3P + N + G	Barge Overflow	1	318501BL			
	3P + N + G	3ØY120/208	9	318509	312509	310509	
	3P + N + G	3ØY277/480	7	318519	312519	310519	
	3P + N + G	3ØY347/600	5	318505	312505	310505	
<b>7</b>	6P + G	250	9		312709	310709	
	6P + G	480	7		312719	310719	

BL devices are US Coast Guard required as per 46CFR Ch.1, 39.20-9.



## FEMALE RECEPTACLES

			WATERTIGHT (IP67)			SPLASHPROOF (IP44)			
			Straight	Angled 15°	Angled 80°	Straight	Angled 15°	Angled 80°	
<b>3</b>	2P + G	250 DC	3	419315	519315	518315	410315	510315	514315
	1P + N + G	125	4	419316	519316	518316	410316	510316	514316
	2P + G	250	6	419306	519306	518306	410306	510306	514306
	1P + N + G	277	5	419317	519317	518317	410317	510317	514317
	2P + G	480	7	419319	519319	518319	410319	510319	514319
<b>4</b>	2P + N + G	125/250	12	419424	519424	518424	410424	510424	514424
	3P + G	3Ø250	9	419409	519409	518409	410409	510409	514409
	3P + G	3Ø480	7	419419	519419	518419	410419	510419	514419
	3P + G	3Ø600	5	419405	519405	518405	410405	510405	514405
<b>5</b>	3P + N + G	Barge Overflow	1	419501BL	519501BL	518501BL			
	3P + N + G	3ØY120/208	9	419509	519509	518509	410509	510509	514509
	3P + N + G	3ØY277/480	7	419519	519519	518519	410519	510519	514519
	3P + N + G	3ØY347/600	5	419505	519505	518505	410505	510505	514505
<b>7</b>	6P + G	250	9				411709		514709
	6P + G	480	7				411719		514719

Note: See pages 16 and 17 for surface mount receptacles and back boxes.





## MALE INLETS

			WATERTIGHT (IP67)		SPLASHPROOF (IP44)			
			Angled 80°	Surface Mount*	Straight	Angled 80°	Surface Mount*	
<b>3</b>	2P + G	250 DC	3	619315	618315	615315	611315	
	1P + N + G	125	4	619316	618316	615316	611316	
	2P + G	250	6	619306	618306	615306	611306	
	1P + N + G	277	5	619317	618317	615317	611317	
	2P + G	480	7	619319	618319	615319	611319	
<b>4</b>	2P + N + G	125/250	12	619424	618424	615424	611424	616424
	3P + G	3Ø250	9	619409	618409	615409	611409	616409
	3P + G	3Ø480	7	619419	618419	615419	611419	616419
	3P + G	3Ø600	5	619405	618405	615405	611405	616405
<b>5</b>	3P + N + G	Barge Overflow	1	619501BL	618501BL			
	3P + N + G	3ØY120/208	9	619509	618509	615509	611509	616509
	3P + N + G	3ØY277/480	7	619519	618519	615519	611519	616519
	3P + N + G	3ØY347/600	5	619505	618505	615505	611505	616505
<b>7</b>	6P + G	250	9			615709	611709	616709
	6P + G	480	7			615719	611719	616719

BL devices are US Coast Guard required as per 46CFR Ch.1, 39.20-9.



## MALE PLUGS

  Certified

			WATERTIGHT (IP67)	SPLASHPROOF (IP44)			
				Standard Version (with cable gland)	Economical Version (with cable sleeve)	Low Profile Angled 90°	
	Poles and Wires	Voltage AC (Except where noted)	Clock Position of Ground Contact				
<b>3</b>	2P + G	250 DC	3	239315	231315	230315	236315
	1P + N + G	125	4	239316	231316	230316	236316
	2P + G	250	6	239306	231306	230306	236306
	1P + N + G	277	5	239317	231317	230317	236317
	2P + G	480	7	239319	231319	230319	236319
<b>4</b>	2P + N + G	125/250	12	238424	232424	230424	236424
	3P + G	3Ø250	9	238409	232409	230409	236409
	3P + G	380/440*	3	238403*			
	3P + G	3Ø480	7	238419	232419	230419	236419
	3P + G	3Ø600	5	238405	232405	230405	236405
<b>5</b>	3P + N + G	50-600 400Hz	2	238502	232502	230502	236502
	3P + N + G	3ØY120/208	9	238509	232509	230509	236509
	3P + N + G	3ØY277/480	7	238519	232519	230519	236519
	3P + N + G	3ØY347/600	5	238505	232505	230505	236505
<b>7</b>	6P + G	250	9		232709	230709	
	6P + G	480	7		232719	230719	

## FEMALE CONNECTORS

  Certified

			WATERTIGHT (IP67)	SPLASHPROOF (IP44)		
				Standard Version (with cable gland)	Economical Version (with cable sleeve)	
	Poles and Wires	Voltage AC (Except where noted)	Clock Position of Ground Contact			
<b>3</b>	2P + G	250 DC	3	339315	331315	330315
	1P + N + G	125	4	339316	331316	330316
	2P + G	250	6	339306	331306	330306
	1P + N + G	277	5	339317	331317	330317
	2P + G	480	7	339319	331319	330319
<b>4</b>	2P + N + G	125/250	12	338424	332424	330424
	3P + G	3Ø250	9	338409	332409	330409
	3P + G	380/440*	3	338403*		
	3P + G	3Ø480	7	338419	332419	330419
	3P + G	3Ø600	5	338405	332405	330405
<b>5</b>	3P + N + G	50-600 400Hz	2	338502	332502	330502
	3P + N + G	3ØY120/208	9	338509	332509	330509
	3P + N + G	3ØY277/480	7	338519	332519	330519
	3P + N + G	3ØY347/600	5	338505	332505	330505
<b>7</b>	6P + G	250	9		332709	330709
	6P + G	480	7		332719	330719

\* Only for refrigerated containers. Supplied with stainless steel assembly screws and friction ring.

## FEMALE RECEPTACLES

Certified

			WATERTIGHT (IP67)			SPLASHPROOF (IP44)			
			Straight	Angled 15°	Angled 80°	Straight	Angled 15°	Angled 80°	
Poles and Wires	Voltage AC (Except where noted)	Clock Position of Ground Contact							
<b>3</b>	2P + G	250 DC	3	439315	539315	538315	430315	530315	534315
	1P + N + G	125	4	439316	539316	538316	430316	530316	534316
	2P + G	250	6	439306	539306	538306	430306	530306	534306
	1P + N + G	277	5	439317	539317	538317	430317	530317	534317
	2P + G	480	7	439319	539319	538319	430319	530319	534319
<b>4</b>	2P + N + G	125/250	12	439424	539424	538424	430424	530424	534424
	3P + G	3Ø250	9	439409	539409	538409	430409	530409	534409
	3P + G	380/440*	3	439403*					
	3P + G	3Ø480	7	439419	539419	538419	430419	530419	534419
	3P + G	3Ø600	5	439405	539405	538405	430405	530405	534405
<b>5</b>	3P + N + G	50-600 400Hz	2	439502	539502	538502	430502	530502	534502
	3P + N + G	3ØY120/208	9	439509	539509	538509	430509	530509	534509
	3P + N + G	3ØY277/480	7	439519	539519	538519	430519	530519	534519
	3P + N + G	3ØY347/600	5	439505	539505	538505	430505	530505	534505
<b>7</b>	6P + G	250	9				431709		534709
	6P + G	480	7				431719		534719

Note: See pages 16 and 17 for surface mount receptacles and back boxes.

## MALE INLETS



Certified

			WATERTIGHT (IP67)		SPLASHPROOF (IP44)			
			Angled 80°	Surface Mount**	Straight	Angled 80°	Surface Mount**	
Poles and Wires	Voltage AC (Except where noted)	Clock Position of Ground Contact						
<b>3</b>	2P + G	250 DC	3	639315	638315	635315	631315	636315
	1P + N + G	125	4	639316	638316	635316	631316	636316
	2P + G	250	6	639306	638306	635306	631306	636306
	1P + N + G	277	5	639317	638317	635317	631317	636317
	2P + G	480	7	639319	638319	635319	631319	636319
<b>4</b>	2P + N + G	125/250	12	639424	638424	635424	631424	636424
	3P + G	3Ø250	9	639409	638409	635409	631409	636409
	3P + G	380/440*	3	639403*	638403*			
	3P + G	3Ø480	7	639419	638419	635419	631419	636419
	3P + G	3Ø600	5	639405	638405	635405	631405	636405
<b>5</b>	3P + N + G	50-600 400Hz	2	639502	638502	635502	631502	636502
	3P + N + G	3ØY120/208	9	639509	638509	635509	631509	636509
	3P + N + G	3ØY277/480	7	639519	638519	635519	631519	636519
	3P + N + G	3ØY347/600	5	639505	638505	635505	631505	636505
<b>7</b>	6P + G	250	9			635709	631709	636709
	6P + G	480	7			635719	631719	636719

\* Only for refrigerated containers.



## MALE PLUGS

  Certified

			WATERTIGHT (IP67)	SPLASHPROOF (IP44)		
				Standard Version (with cable gland)	Economical Version (with cable sleeve)	
Poles and Wires (With pilot)	Voltage AC (Except where noted)	Clock Position of Ground Contact				
<b>3</b>	2P + G	250 DC	3	269315	261315	260315
	1P + N + G	125	4	269316	261316	260316
	2P + G	250	6	269306	261306	260306
	1P + N + G	277	5	269317	261317	260317
	2P + G	480	7	269319	261319	260319
<b>4</b>	2P + N + G	125/250	12	269424	261424	260424
	3P + G	3Ø250	9	269409	261409	260409
	3P + G	3Ø480	7	269419	261419	260419
	3P + G	3Ø600	5	269405	261405	260405
<b>5</b>	3P + N + G	50-600 400Hz	2	269502	261502	260502
	3P + N + G	3ØY120/208	9	269509	261509	260509
	3P + N + G	3ØY277/480	7	269519	261519	260519
	3P + N + G	3ØY347/600	5	269505	261505	260505







## FEMALE CONNECTORS

  Certified

			WATERTIGHT (IP67)	SPLASHPROOF (IP44)		
				Standard Version (with cable gland)	Economical Version (with cable sleeve)	
Poles and Wires (With pilot)	Voltage AC (Except where noted)	Clock Position of Ground Contact				
<b>3</b>	2P + G	250 DC	3	369315	361315	360315
	1P + N + G	125	4	369316	361316	360316
	2P + G	250	6	369306	361306	360306
	1P + N + G	277	5	369317	361317	360317
	2P + G	480	7	369319	361319	360319
<b>4</b>	2P + N + G	125/250	12	369424	361424	360424
	3P + G	3Ø250	9	369409	361409	360409
	3P + G	3Ø480	7	369419	361419	360419
	3P + G	3Ø600	5	369405	361405	360405
<b>5</b>	3P + N + G	50-600 400Hz	2	369502	361502	360502
	3P + N + G	3ØY120/208	9	369509	361509	360509
	3P + N + G	3ØY277/480	7	369519	361519	360519
	3P + N + G	3ØY347/600	5	369505	361505	360505

## FEMALE RECEPTACLES





**UL LISTED** **SP** Certified

			WATERTIGHT (IP67)			SPLASHPROOF (IP44)			
			Straight	Angled 15°	Angled 80°	Straight	Angled 15°	Angled 80°	
Poles and Wires (With pilot)	Voltage AC (Except where noted)	Clock Position of Ground Contact							
<b>3</b>	2P + G	250 DC	3	469315	569315	568315	460315	560315	564315
	1P + N + G	125	4	469316	569316	568316	460316	560316	564316
	2P + G	250	6	469306	569306	568306	460306	560306	564306
	1P + N + G	277	5	469317	569317	568317	460317	560317	564317
	2P + G	480	7	469319	569319	568319	460319	560319	564319
<b>4</b>	2P + N + G	125/250	12	469424	569424	568424	460424	560424	564424
	3P + G	3Ø250	9	469409	569409	568409	460409	560409	564409
	3P + G	3Ø480	7	469419	569419	568419	460419	560419	564419
	3P + G	3Ø600	5	469405	569405	568405	460405	560405	564405
<b>5</b>	3P + N + G	50-600 400Hz	2	469502	569502	568502	460502	560502	564502
	3P + N + G	3ØY120/208	9	469509	569509	568509	460509	560509	564509
	3P + N + G	3ØY277/480	7	469519	569519	568519	460519	560519	564519
	3P + N + G	3ØY347/600	5	469505	569505	568505	460505	560505	564505

Note: See pages 16 and 17 for surface mount receptacles and back boxes.

## MALE INLETS

**UL LISTED** **SP** Certified

			WATERTIGHT (IP67)		SPLASHPROOF (IP44)		
			Angled 80°	Surface Mount*	Straight	Angled 80°	
Poles and Wires (With pilot)	Voltage AC (Except where noted)	Clock Position of Ground Contact					
<b>3</b>	2P + G	250 DC	3	669315	668315		661315
	1P + N + G	125	4	669316	668316		661316
	2P + G	250	6	669306	668306		661306
	1P + N + G	277	5	669317	668317		661317
	2P + G	480	7	669319	668319		661319
<b>4</b>	2P + N + G	125/250	12	669424	668424		661424
	3P + G	3Ø250	9	669409	668409		661409
	3P + G	3Ø480	7	669419	668419		661419
	3P + G	3Ø600	5	669405	668405		661405
<b>5</b>	3P + N + G	50-600 400Hz	2	669502	668502	665502	661502
	3P + N + G	3ØY120/208	9	669509	668509	665509	661509
	3P + N + G	3ØY277/480	7	669519	668519	665519	661519
	3P + N + G	3ØY347/600	5	669505	668505	665505	661505

## MALE PLUGS

**UL LISTED** **SF Certified**

WATERTIGHT (IP67)



	Poles and Wires (With pilot)	Voltage AC (Except where noted)	Clock Position of Ground Contact	
<b>3</b>	2P + G	250 DC	3	279315
	1P + N + G	125	4	279316
	2P + G	250	6	279318
	1P + N + G	277	5	279317
	2P + G	480	7	279319
<b>4</b>	2P + N + G	125/250	12	279424
	3P + G	3Ø250	9	279421
	3P + G	3Ø480	7	279419
	3P + G	3Ø600	5	279417
<b>5</b>	3P + N + G	3ØY120/208	9	279521
	3P + N + G	3ØY277/480	7	279519
	3P + N + G	3ØY347/600	5	279517

## FEMALE CONNECTORS

**UL LISTED** **SF Certified**

WATERTIGHT (IP67)





	Poles and Wires (With pilot)	Voltage AC (Except where noted)	Clock Position of Ground Contact	
<b>3</b>	2P + G	250 DC	3	379315
	1P + N + G	125	4	379316
	2P + G	250	6	379318
	1P + N + G	277	5	379317
	2P + G	480	7	379319
<b>4</b>	2P + N + G	125/250	12	379424
	3P + G	3Ø250	9	379421
	3P + G	3Ø480	7	379419
	3P + G	3Ø600	5	379417
<b>5</b>	3P + N + G	3ØY120/208	9	379521
	3P + N + G	3ØY277/480	7	379519
	3P + N + G	3ØY347/600	5	379517

Note: 100-Amp devices are only available in IP67-Watertight configuration.

## FEMALE RECEPTACLES



Certified

			WATERTIGHT (IP67)		
			Straight	Angled 15°	
Poles and Wires (With pilot)	Voltage AC (Except where noted)	Clock Position of Ground Contact			
<b>3</b>	2P + G	250 DC	3	479315	579315
	1P + N + G	125	4	479316	579316
	2P + G	250	6	479318	579318
	1P + N + G	277	5	479317	579317
	2P + G	480	7	479319	579319
<b>4</b>	2P + N + G	125/250	12	479424	579424
	3P + G	3Ø250	9	479421	579421
	3P + G	3Ø480	7	479419	579419
	3P + G	3Ø600	5	479417	579417
<b>5</b>	3P + N + G	3ØY120/208	9	479521	579521
	3P + N + G	3ØY277/480	7	479519	579519
	3P + N + G	3ØY347/600	5	479517	579517

Note: See pages 16 and 17 for surface mount receptacles and back boxes.

## MALE INLETS

Certified

			WATERTIGHT (IP67)		
			Straight	Surface Mount*	
Poles and Wires (With pilot)	Voltage AC (Except where noted)	Clock Position of Ground Contact			
<b>3</b>	2P + G	250 DC	3	679315	678315
	1P + N + G	125	4	679316	678316
	2P + G	250	6	679318	678318
	1P + N + G	277	5	679317	678317
	2P + G	480	7	679319	678319
<b>4</b>	2P + N + G	125/250	12	679424	678424
	3P + G	3Ø250	9	679421	678421
	3P + G	3Ø480	7	679419	678419
	3P + G	3Ø600	5	679417	678417
<b>5</b>	3P + N + G	3ØY120/208	9	679521	678521
	3P + N + G	3ØY277/480	7	679519	678519
	3P + N + G	3ØY347/600	5	679517	678517

## SURFACE MOUNT RECEPTACLES



			WATERTIGHT (IP67)				SPLASHPROOF (IP44)			
			20 Amps	30 Amps	60 Amps	100 Amps	20 Amps	30 Amps	60 Amps	
No. of Wires	Voltage AC	Clock Position of Ground Contact								
<b>3</b>	2P + G	250 DC	3	119315	139315		179315	111315	131315	
	1P + N + G	125	4	119316	139316		179316	111316	131316	
	2P + G	250	6	119306	139306		179318	111306	131306	
	1P + N + G	277	5	119317	139317		179317	111317	131317	
	2P + G	480	7	119319	139319		179319	111319	131319	
<b>4</b>	2P + N + G	125/250	12	119424	139424	169424	179424	111424	131424	161424
	3P + G	3Ø250	9	119409	139409	169409	179421	111409	131409	161409
	3P + G	380/440**	3		139403*					
	3P + G	3Ø480	7	119419	139419	169419	179419	111419	131419	161419
	3P + G	3Ø600	5	119405	139405	169405	179417	111405	131405	161405
<b>5</b>	3P + N + G	Barge Overflow	1	119501BL						
	3P + N + G	3ØY120/208	9	119509	139509	169509	179521	111509	131509	161509
	3P + N + G	3ØY277/480	7	119519	139519	169519	179519	111519	131519	161519
	3P + N + G	3ØY347/600	5	119505	139505	169505	179517	111505	131505	161505
<b>7</b>	6P + G	250	9					111709	131709	
	6P + G	480	7					111719	131719	

\* Only for refrigerated containers. \*\*Surface mount receptacles combine a back box and receptacle into one compact device.

### CEEtyp - TEST PLUGS



Phase sequence control plugs quickly allow for inspection of phase rotational direction within seconds. The devices are provided with two LEDs:

- **GREEN** lamp lights: phase sequence is correct.....
- **RED** lamp lights: phase sequence is wrong.....
- **GREEN & RED** lamps light: one phase is missing.....

### ORDERING INFORMATION

Amps	No. of Wires	RANGE Voltage AC	Clock Position of Ground Contact	Male Plug
16	3P + G	110V - 690V	6	210406DF
16	3P + N + G	110V - 690V	6	210DF
32	3P + G	110V - 690V	6	230406DF
32	3P + N + G	110V - 690V	6	230DF
63	3P + G	110V - 690V	6	260406DF
63	3P + N + G	110V - 690V	6	260DF



### CEEtyp- Phase Inverters



Phase inverters: Incorrectly installed rotating fields can easily be set right by quickly changing the polarity of the motor without having to rewire the phasing. Three-steps, three-minutes or less, job complete!

- Step 1 - Turn the power off
- Step 2 - Rotate the phase pins
- Step 3 - Turn the power on

Questions regarding the Phase Inverter? Call us today!

### ORDERING INFORMATION

Amps	No. of Wires	Voltage AC	Clock Position of Ground Contact	Male Plug
16	3P + N + G	400	6	210PH
32	3P + N + G	400	6	230PH



## BACK BOXES for use with Walther straight watertight and splashproof receptacles.



Cat. No.	Description	Hub Size	Dimensions (inches)							Cubic Inch Capacity
			A	B	C	D	E	F	G	
BE3-B75	20° angle for 20A, 4 and 5 wire reepts. and all 30A reepts.	3/4"	3.34	0.97	1.12	4.12	4.00	0.25		20.4
BE3-B100		1"								
BE6-B125	20° angle for all 60A receptacles	1 1/4"	4.41	1.41	2.09	5.63	5.00	0.28	3.00	59.7
BE6-B150		1 1/2"								
BE10-B150	20° angle for all 100A receptacles	1 1/2"	5.18	1.78	2.50	7.71	5.50	.34	4.00	96.6
BE10-B200		2"								

### Cast Aluminum Junction Boxes for Straight Watertight and Splashproof Female Receptacles

Epoxy-coated junction boxes are corrosion resistant and designed to pass the 500-hour salt spray test, the UL hosedown and external icing tests.

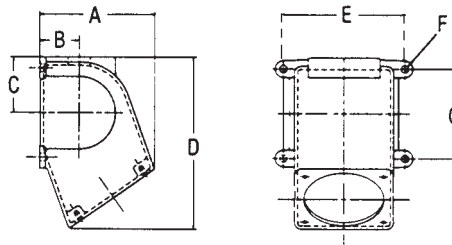

## BACK BOX ADAPTER PLATES for use with Hubbell back boxes.

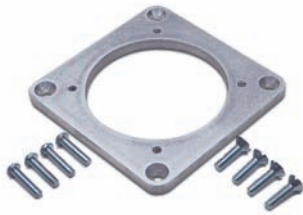

Cat. No.	Walther Receptacle	For use with Hubbell Back Box
BB20-3W	20A, 3 Wire	BB201W, BB301W, FT202W or FT302W
BB20-345W	20A, 4 & 5 Wire 30A, 3, 4 & 5 Wire	BB201W, BB301W, FT202W or FT302W
BB60-345W	60A, 3, 4 & 5 Wire	BB601W, BB602W or FW60/100
BB100-345W	100A, 3, 4 & 5 Wire	BB1001W, BB1002W or FW60/100



Can your current device withstand this type of abuse?



Built tough for the most demanding use!



Oil-Grime-Water-we can take it all!

## PG THREAD TO NPT THREAD ADAPTERS



Cat. No.	Description	Std. Pkg.
PG11-38	PG11 to 3/8" NPT Adapter	25
PG11-50	PG11 to 1/2" NPT Adapter	25
PG135-50	PG13,5 to 1/2" NPT Adapter	25
PG16-50	PG16 to 1/2" NPT Adapter	25
PG21-75	PG21 to 3/4" NPT Adapter	25
PG29-100	PG29 to 1" NPT Adapter	10
PG29-125	PG29 to 1 1/4" NPT Adapter	5
PG36-125	PG36 to 1 1/4" NPT Adapter	5

For PG thread sizes to NPT thread sizes not shown, consult technical service for price, delivery and minimum order quantities.

## WATERTIGHT CLOSURE CAPS for use with watertight male plugs and inlets



Cat. No.	Poles and Wires	Amperage Rating	Std. Pkg Quantity
613300	3 Wire	20	5
633400		30	5
663500		60	2
673500		100	2
613400	4 Wire	20	5
633400		30	5
663500		60	2
673500		100	2
613500	5 Wire	20	5
633500		30	5
663500		60	2
673500		100	2

## SPLASHPROOF CLOSURE CAPS for use with splashproof male plugs and inlets



Cat. No.	Poles and Wires	Amperage Rating	Std. Pkg Quantity
614300	3 Wire	20	5
634400		30	5
664500		60	2
614400	4 Wire	20	5
634400		30	5
664500		60	2
614500	5 Wire	20	5
634500		30	5
664500		60	2

## PRE-INSTALLED CLOSURE CAPS



Closure caps provide watertight or splashproof protection to disconnected plugs and inlets. The possibility of removing or misplacing the cap can be eliminated by securing the chain or nylon strap to the inlet flange. If the closure cap will be fastened to a plug, Walther can pre-install the cap on the device. This factory installation assures safe and reliable utilization of the two components. Contact customer service for ordering information.

Minimum test requirements

**ELECTRICAL**

<b>Insulation Resistance</b> Per IEC 309-1, Clause 19	500V for 1 min. Resistance $\geq 5M \Omega$
<b>Dielectric Strength</b> Per IEC 309-1, Clause 19	3000V for 1 min.
<b>Norm. Operation, Connect &amp; Disconnect Cycles</b> Per IEC 309-1, Clause 21	See Table 1
<b>Breaking Capacity</b> Per IEC 309-1, Clause 20	Tested at 110 % of the rated operating voltage and 125% of the rated current.
<b>Temperature Rise</b> Per IEC 309-1, Clause 22	Maximum 50 K rise at full rated current.

**MECHANICAL**

<b>Cable Secureness</b> Per IEC 309, Clause 23	See Table 2
<b>Impact</b> Per IEC 309, Clause 24	A device is wired with a 2.25m length of flexible cord and dropped from a height of 75 cm, 8 times. The device is then tested for applicable degrees of protection against moisture.

**ENVIRONMENTAL**

<b>Flammability</b>	Self-extinguishing Per IEC 309-1, Clause 27
<b>Ambient Temperature Range</b>	Minimum: -25°C with impact Maximum: 90°C
<b>Moisture Resistance</b>	Watertight (IP67): Device immersed for 24 hours in water at a temp. of 25°C, the highest point of the device being 5cm (2") below the water level. Splashproof (IP44): Device is sprayed with water for 10 minutes and immediately afterwards subjected to splashing water in all directions (360°).
<b>UV Resistance</b>	Exposed plastic materials are UV stabilized.

TABLE 1

Connect and Disconnect Cycles			
Device Rating Amperes	Cycles with Load at Rated Current and Voltage	No-Load Cycles	Sequence
16	5000 p.f of 0.6	0	-
32	1000 p.f of 0.6	1000	Alternating
63	1000 p.f of 0.6	1000	Alternating
125	250 p.f of 0.7	250	Alternating

The test sequence is conducted by using a no-load, followed by a load sequence.

TABLE 2

Cable Secureness Test			
Device Rating Amperes	Force	Torque	Maximum Displacement
	N	N•m	mm
16	80	0.350	2
32	100	0.425	2
63	120	0.8	2
125	200	1.5	2

The flexible cord or cable is twisted and pulled. Values for the applied twisting torque and force of pull are shown in Table 2. In all cases the cord displacement is less than 2mm.



**DECLARATION OF CONFORMITY**

WALTHER WERKE, Ferdinand Walther GmbH  
Ramsener Strasse 6  
67304 Eisenberg

We declare, under our sole responsibility, the conformity of the following products and standards:

Plugs and Sockets (Pin and Sleeve devices)  
DIN EN 60 309, T. 1  
DIN EN 60 309, T. 2

This declaration of conformity is according to the EC regulations 73/23, 91/368 and 89/336 (Low Voltage Directive), module A, in consideration of DIN EN 45 014.



Norway



Germany



Finland



Switzerland



Austria



Sweden



Belgium



Denmark



Italy



Netherlands



Czechoslovakia



Hungary



Russia



For all plugs, sockets & receptacles



United States



Canada







China  
\*part specific

DIN EN ISO 9001 Certificate Registration No. 4678-01







## MALE PLUGS

 LISTED

			WATERTIGHT (IP67)	SPLASHPROOF (IP44)			
					with cable gland	with cable sleeve	Angled 90°
No. of Wires	Voltage AC	Clock Position of Ground Contact					
<b>3</b>	2P + G	110	4	219304	211304	210304	216304
		230	6	219306	211306	210306	216306
		400	9	219309	211309	210309	216309
<b>4</b>	3P + G	110	4	219404	211404	210404	216404
		230	9	219409	211409	210409	216409
		400	6	219406	211406	210406	216406
		440	11	219411	211411	210411	216411
		500	7	219407	211407	210407	216407
		>50 (100-300Hz)	10	219410	211410	210410	216410
		>50 (300-500Hz)	2	219402	211402	210402	216402
<b>5</b>	3P + N + G	110	4	219504	211504	210504	216504
		230	9	219509	211509	210509	216509
		400	6	219	211	210	216
		440	11	219511	211511	210511	216511
<b>7</b>	6P + G	400	6		211706	210706	

## FEMALE CONNECTORS (Couplers)

 LISTED

			WATERTIGHT (IP67)	SPLASHPROOF (IP44)			
					with cable gland	with cable sleeve	Angled 90°
No. of Wires	Voltage AC	Clock Position of Ground Contact					
<b>3</b>	2P + G	110	4	319304	311304	310304	316304
		230	6	319306	311306	310306	316306
		400	9	319309	311309	310309	316309
<b>4</b>	3P + G	110	4	319404	311404	310404	
		230	9	319409	311409	310409	
		400	6	319406	311406	310406	
		440	11	319411	311411	310411	
		500	7	319407	311407	310407	
		>50 (100-300Hz)	10	319410	311410	310410	
		>50 (300-500Hz)	2	319402	311402	310402	
<b>5</b>	3P + N + G	110	4	319504	311504	310504	
		230	9	319509	311509	310509	
		400	6	319	311	310	
		440	11	319511	311511	310511	
<b>7</b>	6P + G	400	6		311706	310706	

## FEMALE PANEL MOUNTED SOCKET-OUTLET

**UL LISTED**

			WATERTIGHT (IP67)			SPLASHPROOF (IP44)		
			Straight	Angled 15°	Angled 80°	Straight	Angled 15°	Angled 80°
<b>3</b>	2P + G	110						
		230	419306	519306	518306	410306	510306	514306
		400	419309	519309	518309	410309	510309	514309
<b>4</b>	3P + G	110	419404	519404	518404	410404	510404	514404
		230	419409	519409	518409	410409	510409	514409
		400	419406	519406	518406	410406	510406	514406
		440	419411	519411	518411	410411	510411	514411
		500	419407	519407	518407	410407	510407	514407
		>50 (100-300Hz)	419410	519410	518410	410410	510410	514410
		>50 (300-500Hz)	419402	519402	518402	410402	510402	514402
<b>5</b>	3P + N + G	110	419504	519504	518504	410504	510504	514504
		230	419509	519509	518509	410509	510509	514509
		400	419	519	518	410	510	514
		440	419511	519511	518511	410511	510511	514511
<b>7</b>	6P + G	400				411706		514706

Note: See page 28 for surface mount socket-outlets.





## MALE APPLIANCE PLUG (Inlet)

**UL LISTED**

			WATERTIGHT (IP67)		SPLASHPROOF (IP44)			
			Angled 80°	Surface Mount	Straight	Angled 80°	Surface Mount External Mounting	Surface Mount Internal Mounting
<b>3</b>	2P + G	110						
		230	619306	618306	615306	611306	610306	
		400	619309	618309	615309	611309	610309	
<b>4</b>	3P + G	110	619404	618404	615404	611404	610404	616404
		230	619409	618409	615409	611409	610409	616409
		400	619406	618406	615406	611406	610406	616406
		440	619411	618411	615411	611411	610411	616411
		500	619407	618407	615407	611407	610407	616407
		>50 (100-300Hz)	619410	618410	615410	611410	610410	616410
		>50 (300-500Hz)	619402	618402	615402	611402	610402	616402
<b>5</b>	3P + N + G	110	619504	618504	615504	611504	610504	616504
		230	619509	618509	615509	611509	610509	616509
		400	619	618	615	611	610	616
		440	619511	618511	615511	611511	610511	616511
<b>7</b>	6P + G	400			615706	611706	610706	616706



## MALE PLUGS

**UL LISTED**

			WATERTIGHT (IP67)	SPLASHPROOF (IP44)		
					with cable gland	with cable sleeve
No. of Wires	Voltage AC	Clock Position of Ground Contact				
<b>3</b>	2P + G	110	239304	231304	230304	236304
		230	239306	231306	230306	236306
		400	239309	231309	230309	236309
<b>4</b>	3P + G	110	239404	231404	230404	236404
		230	239409	231409	230409	236409
		400	239406	231406	230406	236406
		380/440*	239403*			
		440	239411	231411	230411	236411
		500	239407	231407	230407	236407
		>50 (100-300Hz)	239410	231410	230410	236410
>50 (300-500Hz)	239402	231402	230402	236402		
<b>5</b>	3P + N + G	110	239504	231504	230504	236504
		230	239509	231509	230509	236509
		400	239	231	230	236
		440	239511	231511	230511	236511
<b>7</b>	6P + G	400		231706	230706	

## FEMALE CONNECTORS (Couplers)







**UL LISTED**

			WATERTIGHT (IP67)	SPLASHPROOF (IP44)	
					with cable gland
No. of Wires	Voltage AC	Clock Position of Ground Contact			
<b>3</b>	2P + G	110	339304	331304	330304
		230	339306	331306	330306
		400	339309	331309	330309
<b>4</b>	3P + G	110	339404	331404	330404
		230	339409	331409	330409
		400	339406	331406	330406
		380/440*	339403*		
		440	339411	331411	330411
		500	339407	331407	330407
		>50 (100/300Hz)	339410	331410	330410
>50 (300/500Hz)	339402	331402	330402		
<b>5</b>	3P + N + G	110	339504	331504	330504
		230	339509	331509	330509
		400	339	331	330
		440	339511	331511	330511
<b>7</b>	6P + G	400		331706	330706

\* Only for refrigerated containers.

## FEMALE PANEL MOUNTED SOCKET-OUTLET







**UL LISTED**

			WATERTIGHT (IP67)			SPLASHPROOF (IP44)		
			Straight	Angled 15°	Angled 80°	Straight	Angled 15°	Angled 80°
<b>3</b>	2P + G	110						
		230	439306	539306	538306	430306	530306	534306
		400	439309	539309	538309	430309	530309	534309
<b>4</b>	3P + G	110	439404	539404	538404	430404	530404	534404
		230	439409	539409	538409	430409	530409	534409
		400	439406	539406	538406	430406	530406	534406
		380/440*	439403*					
		440	439411	539411	538411	430411	530411	534411
		500	439407	539407	538407	430407	530407	534407
		>50 (100-300Hz)	439410	539410	538410	430410	530410	534410
>50 (300-500Hz)	439402	539402	538402	430402	530402	534402		
<b>5</b>	3P + N + G	110	439504	539504	538504	430504	530504	534504
		230	439509	539509	538509	430509	530509	534509
		400	439	539	538	430	530	534
		440	439511	539511	538511	430511	530511	534511
<b>7</b>	6P + G	400				431706		534706

Note: See page 28 for surface mount socket-outlets.

## MALE APPLIANCE PLUG (Inlet)



**UL LISTED**

			WATERTIGHT (IP67)		SPLASHPROOF (IP44)			
			Angled 80°	Surface Mount	Straight	Angled 80°	Surface Mount External Mounting	Surface Mount Internal Mounting
<b>3</b>	2P + G	110						
		230	639306	638306	635306	631306	630306	636306
		400	639309	638309	635309	631309	630309	636309
<b>4</b>	3P + G	110	639404	638404	635404	631404	630404	636404
		230	639409	638409	635409	631409	630409	636409
		400	639406	638406	635406	631406	630406	636406
		380/440*	639403*	638403*				
		440	639411	638411	635411	631411	630411	636411
		500	639407	638407	635407	631407	630407	636407
		>50 (100-300Hz)	639410	638410	635410	631410	630410	636410
>50 (300-500Hz)	639402	638402	635402	631402	630402	636402		
<b>5</b>	3P + N + G	110	639504	638504	635504	631504	630504	636504
		230	639509	638509	635509	631509	630509	636509
		400	639	638	635	631	630	636
		440	639511	638511	635511	631511	630511	636511
<b>7</b>	6P + G	400			635706	631706	630706	636706

\* Only for refrigerated containers.



## MALE PLUGS

**UL LISTED**

			WATERTIGHT (IP67)	SPLASHPROOF (IP44)	
					with cable gland
No. of Wires	Voltage AC	Clock Position of Ground Contact			
<b>3</b>	2P + G	110	269304	261304	260304
		230	269306	261306	260306
		400	269309	261309	260309
<b>4</b>	3P + G	110	269404	261404	260404
		230	269409	261409	260409
		400	269406	261406	260406
		440	269411	261411	260411
		500	269407	261407	260407
<b>5</b>	3P + N + G	110	269504	261504	260504
		230	269509	261509	260509
		400	269	261	260
		440	269511	261511	260511

## FEMALE CONNECTORS (Couplers)







**UL LISTED**

			WATERTIGHT (IP67)	SPLASHPROOF (IP44)	
					with cable gland
No. of Wires	Voltage AC	Clock Position of Ground Contact			
<b>3</b>	2P + G	110	369304	361304	360304
		230	369306	361306	360306
		400	369309	361309	360309
<b>4</b>	3P + G	110	369404	361404	360404
		230	369409	361409	360409
		400	369406	361406	360406
		440	369411	361411	360411
		500	369407	361407	360407
<b>5</b>	3P + N + G	110	369504	361504	360504
		230	369509	361509	360509
		400	369	361	360
		440	369511	361511	360511



## FEMALE PANEL MOUNTED SOCKET-OUTLET





**UL LISTED**

			WATERTIGHT (IP67)			SPLASHPROOF (IP44)		
			Straight	Angled 15°	Angled 80°	Straight	Angled 15°	Angled 80°
<b>3</b>	2P + G	110						
		230	469304	569304	568304	460304	560304	564304
		400	469306	569306	568306	460306	560306	564306
<b>4</b>	3P + G	110	469309	569309	568309	460309	560309	564309
		230	469404	569404	568404	460404	560404	564404
		400	469409	569409	568409	460409	560409	564409
		440	469406	569406	568406	460406	560406	564406
		500	469411	569411	568411	460411	560411	564411
<b>5</b>	3P + N + G	110	469407	569407	568407	460407	560407	564407
		230	469504	569504	568504	460504	560504	564504
		400	469509	569509	568509	460509	560509	564509
		440	469	569	568	460	560	564
		11	469511	569511	568511	460511	560511	564511

Note: See page 28 for surface mount receptacles.

## MALE APPLIANCE PLUG (Inlet)

**UL LISTED**

			WATERTIGHT (IP67)		SPLASHPROOF (IP44)	
			Angled 80°	Surface Mount	Straight	Angled 80°
<b>3</b>	2P + G	110				
		230	669304	668304		661304
		400	669306	668306		661306
<b>4</b>	3P + G	110	669309	668309		661309
		230	669404	668404		661404
		400	669409	668409		661409
		440	669406	668406		661406
		500	669411	668411		661411
<b>5</b>	3P + N + G	110	669407	668407		661407
		230	669504	668504	665504	661504
		400	669509	668509	665509	661509
		440	669	668	665	661
		11	669511	668511	665511	661511

## MALE PLUGS

**UL LISTED**

WATERTIGHT (IP67)



No. of Wires	Voltage AC	Clock Position of Ground Contact	
<b>3</b>	2P + G	110	4
		230	6
		400	9
<b>4</b>	3P + G	110	4
		230	9
		400	6
		440	11
		500	7
<b>5</b>	3P + N + G	110	4
		230	9
		400	6
		440	11

## FEMALE CONNECTORS (Couplers)

**UL LISTED**

WATERTIGHT (IP67)





No. of Wires	Voltage AC	Clock Position of Ground Contact	
<b>3</b>	2P + G	110	4
		230	6
		400	9
<b>4</b>	3P + G	110	4
		230	9
		400	6
		440	11
		500	7
<b>5</b>	3P + N + G	110	4
		230	9
		400	6
		440	11

Note: 125-Amp devices are only available in IP67-Watertight configuration.

## FEMALE PANEL MOUNTED SOCKET-OUTLET



UL LISTED

			WATERTIGHT (IP67)		
			Straight	Angled 15°	
No. of Wires	Voltage AC	Clock Position of Ground Contact			
<b>3</b>	2P + G	110	4	479304	579304
		230	6	479306	579306
		400	9	479309	579309
<b>4</b>	3P + G	110	4	479404	579404
		230	9	479409	579409
		400	6	479406	579406
		440	11	479411	579411
		500	7	479407	579407
<b>5</b>	3P + N + G	110	4	479504	579504
		230	9	479509	579509
		400	6	479	579
		440	11	479511	579511

Note: See page 28 for surface mount receptacles.

## MALE APPLIANCE PLUG (Inlet)

UL LISTED

			WATERTIGHT (IP67)		
			Straight	Surface Mount	
No. of Wires	Voltage AC	Clock Position of Ground Contact			
<b>3</b>	2P + G	110	4	679304	678304
		230	6	679306	678306
		400	9	679309	678309
<b>4</b>	3P + G	110	4	679404	678404
		230	9	679409	678409
		400	6	679406	678406
		440	11	679411	678411
		500	7	679407	678407
<b>5</b>	3P + N + G	110	4	679504	678504
		230	9	679509	678509
		400	6	679	678
		440	11	679511	678511

## SURFACE MOUNT SOCKET-OUTLETS



(Internal Mounting)

			WATERTIGHT (IP67)				SPLASHPROOF (IP44)			
			16 Amps	32 Amps	63 Amps	125 Amps	16 Amps	32 Amps	63 Amps	
No. of Wires	Voltage AC	Clock Position of Ground Contact								
<b>3</b>	2P + G	110	4	119304	139304	179304	111304	131304		
		230	6	119306	139306	179306	111306	131306		
		400	9	119309	139309	179309	111309	131309		
<b>4</b>	3P + G	110	4	119404	139404	169404	179404	111404	131404	161404
		230	9	119409	139409	169409	179409	111409	131409	161409
		400	6	119406	139406	169406	179406	111406	131406	161406
		440	11	119411	139411	169411	179411	111411	131411	161411
		500	7	119407	139407	169407	179407	111407	131407	161407
		>50 (100-300Hz)	10	119410	139410	169410	179410	111410	131410	161410
		>50 (300-500Hz)	2	119402	139402	169402	179402	111402	131402	161402
<b>5</b>	3P + N + G	110	4	119504	139504	169504	179504	111504	131504	161504
		230	9	119509	139509	169509	179509	111509	131509	161509
		400	6	119	139	169	179	111	131	161
		440	11	119511	139511	169511	179511	111511	131511	161511
<b>7</b>	6P + G	400	6				111706	131706		

## SURFACE MOUNT SOCKET-OUTLETS



(External Mounting)

			SPLASHPROOF (IP44)		
			16 Amps	32 Amps	
No. of Wires	Voltage AC	Clock Position of Ground Contact			
<b>3</b>	2P + G	110	4	110304	130304
		230	6	110306	130306
		400	9	110309	130309
<b>4</b>	3P + G	110	4	110404	130404
		230	9	110409	130409
		400	6	110406	130406
		440	11	110411	130411
		500	7	110407	130407
		>50 (100-300Hz)	10	110410	130410
		>50 (300-500Hz)	2	110402	130402
<b>5</b>	3P + N + G	110	4	110504	130504
		230	9	110509	130509
		400	6	110	130
		440	11	110511	130511
<b>7</b>	6P + G	400	6	110706	130706

# NEW PRODUCT - NEW CEE<sub>typ</sub> GENERATION



Standard screw-terminal version: faster and safer



Cable gland: Automatic strain relief plus sealing all in one go



Double safety: two contact screws for vibration-proof wiring



Color coding: safe identification of conductors



The standard version: with screw terminals

Doubly safe: with 2 connection screws per terminal

Automatic cable gland: the absolutely safe solution

Example for 6 h types	
Former part nos.:	Today's part no.:
210 211 212	210
310 311 312	310
230 231 232	230
330 331 332	330







High technology moulding, a patented WALTHER system for perfect sealing

For expert safety: totally splashproof, including strain relief

Durable locking: Fasten front and back part until audible snap

## ORDERING INFORMATION

 3 P + N + E	Ampère	Poles	110 V	230 V	400 V	Conductor cross section	Cable diameter			
			50 a. 60 Hz 5pole 4h	50 a. 60 Hz 5pole 9h	50 a. 60 Hz 5pole 6h					
<b>Part numbers</b>										
 pic. 210	16	5	210 504	210 509	<b>210</b>	1 - 4 mm <sup>2</sup>	7,5 - 19,5 mm	10/60	176	
	32	5	230 504	230 509	<b>230</b>	2,5 - 6 mm <sup>2</sup>	10 - 24,5 mm	10/60	250	
<b>CEE Male Plug ⚠ IP 44, with screw terminals</b>										
 pic. 310	16	5	310 504	310 509	<b>310</b>	1 - 4 mm <sup>2</sup>	7,5 - 19,5 mm	10/60	219	
	32	5	330 504	330 509	<b>330</b>	2,5 - 6 mm <sup>2</sup>	10 - 24,5 mm	10/60	311	
<b>CEE Female Connector (coupler) ⚠ IP 44, with screw terminals</b>										

Consult customer service for other amperage and voltage ratings and configurations.



## The New Walther Watertight Solution!

The new style Walther IP67 plugs and connectors have improved sealing, fast, safe and tight cable gland. The new Walther IP67 plugs and connectors also offer a provision for a padlock to comply with OSHA Lockout/Tagout requirements.



**Double sealing groove:**  
For a larger sealing surface and thus higher tightness.



**Protecting cap:**  
The cap is always at hand since it is undetachably fixed on the bayonet ring

**Padlockable:**  
Protection against unauthorized disconnection from the electric circuit. Stay OSHA Compliant!

### Modes of Connection

You can choose between:

■ **screw terminals:**  
2 connection screws per contact, already with 16 A - for double safety



■ **screwless version:**  
Centrepiece is the distributor ring. When inserting the wires into the slots they are bent by 180°. This serves as anchor. By inserting the distributor ring into the front part and screwing down the back part all wires are contacted in one go.

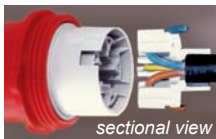

### New Product Features

- Pleasing product design
- Cable gland for better strain relief and tightness.
- Opened hinged lid snaps automatically into closed position when let loose. Thereby increased contact protection even when lid is not yet screwed down.
- Unlimited strain relief with the screwless version - nobody will be able to pull this cable out anymore.
- Padlockable - as protection against unauthorized disconnection from the circuit
- Double sealing groove for more tightness
- Captive protecting cap

### Assembly

- Just screw front and back part together - ready.
- Only screw down cable gland - quick and easy.
- To attach the padlock simply insert its shackle into the hole on the bayonet ring
- Plug and socket, 16 A and 32 A
- Protecting cap (accessory)
- padlock (accessory)



## CEEtyp Plugs and Sockets

### Range of products

3 2P+E                  4 3P+E                  5 3P+N+E		Ampère	Poles	<b>110 V</b> 50 a. 60 Hz <small>3pole 4pole 5pole</small> <small>4h 4h 4h</small>	<b>230 V</b> 50 a. 60 Hz <small>3pole 4pole 5pole</small> <small>6h 9h 9h</small>	<b>400 V</b> 50 a. 60 Hz <small>3pole 4pole 5pole</small> <small>9h 6h 6h</small>	Conductor cross section	Cable diameter		
Part Numbers										
	16	4	219 404	219 409	<b>219 406</b>	1 - 2,5 mm <sup>2</sup>	7,5 - 18,5 mm	10	212	
	16	5	219 504	219 509	<b>219</b>			10	236	
	32	3	239 304	<b>239 306</b>	239 309	2,5 - 6 mm <sup>2</sup>	10 - 22,5 mm	10	290	
	32	4	239 404	239 409	<b>239 406</b>			10	300	
	32	5	239 504	239 509	<b>239</b>			10	340	
	16	4	219 404 SL	219 409 SL	<b>219 406 SL</b>	1 - 2,5 mm <sup>2</sup>	7,5 - 18,5 mm	10	212	
	16	5	219 504 SL	219 509 SL	<b>219 SL</b>			10	236	
	32	3	239 304 SL	<b>239 306 SL</b>	239 309 SL	2,5 - 6 mm <sup>2</sup>	10 - 22,5 mm	10	290	
	32	4	239 404 SL	239 409 SL	<b>239 406 SL</b>			10	300	
	32	5	239 504 SL	239 509 SL	<b>239 SL</b>			10	340	
Fig. 219 <b>CEE Plug IP 67, with screw terminals</b>										
	16	4	319 404	319 409	<b>319 406</b>	1 - 2,5 mm <sup>2</sup>	7,5 - 18,5 mm	10	268	
	16	5	319 504	319 509	<b>319</b>			10	298	
	32	3	339 304	<b>339 306</b>	339 309	2,5 - 6 mm <sup>2</sup>	10 - 22,5 mm	10	351	
	32	4	339 404	339 409	<b>339 406</b>			10	369	
	32	5	339 504	339 509	<b>339</b>			10	415	
	16	4	319 404 SL	319 409 SL	<b>319 406 SL</b>	1 - 2,5 mm <sup>2</sup>	7,5 - 18,5 mm	10	268	
	16	5	319 504 SL	319 509 SL	<b>319 SL</b>			10	298	
	32	3	339 304 SL	<b>339 306 SL</b>	339 309 SL	2,5 - 6 mm <sup>2</sup>	10 - 22,5 mm	10	351	
	32	4	339 404 SL	339 409 SL	<b>339 406 SL</b>			10	369	
	32	5	339 504 SL	339 509 SL	<b>339 SL</b>			10	415	
Fig. 319 <b>CEE Couplers IP 67, with screw terminals</b>										

Consult customer service for other amperage and voltage ratings and configurations.

\* "SL" UL Listing Pending

# IEC 309 PIN & SLEEVE DEVICES • LIGHT & STAGE DEVICES



## Well hidden from View!

It is necessary that electrical installations on stages function without interruption and not be a distraction to the viewers.

## The Walther Electric Solution:

Black devices which prevent bothersome light reflections and thus make the electrical installation on stages almost "invisible"!

Standard Style

New Light & Stage Style



Now You See It

Now You Don't

## Male Plugs IP 44 for Light & Stage Applications

IEC/EN 60 309



2 P+E

3 P+E

3 P+N+E

Amperage

Poles

**110 V**

50 a. 60 Hz

3pole 4pole 5pole  
4h 4h 4h

**230 V**

50 a. 60 Hz

3pole 4pole 5pole  
6h 9h 9h

**400 V**

50 a. 60 Hz

3pole 4pole 5pole  
9h 6h 6h







**500 V**

50 a. 60 Hz

3pole 4pole 5pole  
7h 7h 7h



### Part numbers

	16	3		<b>211 306 SW</b>		10	112
	16	4			<b>211 406 SW</b>	10	154
	16	5			<b>211 SW</b>	10	170
	32	3		<b>231 306 SW</b>		10	211
	32	4			<b>231 406 SW</b>	10	217
	32	5			<b>231 SW</b>	10	240
	63	3		<b>261 306 SW</b>		5	475
	63	4			<b>261 406 SW</b>	5	566
	63	5			<b>261 SW</b>	5	613
125	3		<b>279 306 SW<sup>1)</sup></b>		2	1185	
125	4			<b>279 406 SW<sup>1)</sup></b>	2	1329	
125	5			<b>279 SW<sup>1)</sup></b>	2	1473	
231SW	<b>Plugs with gland entry, in 16 - 63 A = IP 44 , in 125 A = IP 67  <sup>1)</sup></b>						
	16	3	215 304 SW	<b>215 306 SW</b>		10	101
	215306SW	<b>Plugs IP 44  with inverted cable entry</b>					
	16	5			<b>210 SW</b>	10/60	176
	32	5			<b>230 SW</b>	10/60	250
230SW	<b>Plugs IP 44 , with cable gland</b>						

Consult customer service for other amperage and voltage ratings and configurations.





## Female Connectors & Socket-Outlets IP 44 for Light & Stage Applications IEC/EN 60 309

		   2 P+E    3 P+E    3 P+N+E			Amperage	Poles	<b>110 V</b> 50 a. 60 Hz 3pole 4pole 5pole 4h 4h 4h	<b>230 V</b> 50 a. 60 Hz 3pole 4pole 5pole 6h 9h 9h	<b>400 V</b> 50 a. 60 Hz 3pole 4pole 5pole 9h 6h 6h	<b>500 V</b> 50 a. 60 Hz 3pole 4pole 5pole 7h 7h 7h	 	
Part numbers												
	16	3					<b>311 306 SW</b>				10	147
	16	4						<b>311 406 SW</b>			10	197
	16	5						<b>311 SW</b>			10	214
	32	3					<b>331 306 SW</b>				10	265
	32	4						<b>331 406 SW</b>			10	278
	32	5						<b>331 SW</b>			10	300
	63	3					<b>361 306 SW</b>				5	656
	63	4						<b>361 406 SW</b>			5	771
	63	5						<b>361 SW</b>			5	787
	125	3					<b>379 306 SW<sup>2)</sup></b>				2	1362
	125	4						<b>379 406 SW<sup>2)</sup></b>			2	1536
	125	5						<b>379 SW<sup>2)</sup></b>			2	1710
331306SW	<b>Couplers with gland entry, 16 - 63 A = IP 44 , 125 A = IP 67 </b>											
	16	3	315 304 SW				<b>315 306 SW</b>				10	140
	315306SW	<b>Couplers IP 44 , with inverted cable entry</b>										
	16	5						<b>310 SW</b>			10/60	219
	32	5						<b>330 SW</b>			10/60	311
310SW	<b>Couplers IP 44 , with cable gland</b>											
	16	3	410 304 SW				<b>410 306 SW</b>				10	128
	16	4						<b>410 406 SW</b>			10	106
	16	5						<b>410 SW</b>			10	165
	32	3					<b>430 306 SW</b>				10	208
	32	4						<b>430 406 SW</b>			10	215
	32	5						<b>430 SW</b>			10	226
	63	3					<b>460 306 SW</b>				5	586
	63	4						<b>460 406 SW</b>			5	645
	63	5						<b>460 SW</b>			5	776
	125	3					<b>479 306 SW<sup>3)</sup></b>				2	990
	125	4						<b>479 406 SW<sup>3)</sup></b>			2	1155
	125	5						<b>479 SW<sup>3)</sup></b>			2	1319
430SW	<b>Panel sockets, straight, 16 - 63 A = IP 44 , 125 A = IP 67 </b> <sup>3)</sup> , fingerproof acc. to BGV A2											

Consult customer service for other amperage and voltage ratings and configurations.



## SCREW-LESS IDC PLUGS AND CONNECTORS... ...BROUGHT TO YOU BY WALTHER ELECTRIC

### CEEtyp™

CEEtyp plugs and connectors, with insulation displacement technology, are designed to increase productivity and lower the installed cost of wire termination. Utilization of the quick connection system for all wiring jobs, large and small, will speed and improve wire terminations while saving you money. Time and labor savings can be up to 60% when compared to other connection systems.

No wire stripping — the installation is fast and easy. The usual stripping procedure is not required. Simply remove outer cable jacket to length, fold over and position the conductors in the piercing pockets, and the connection is complete.

The Walther quick connection system provides an optimum electrical bond between the conductor and the piercing metal. Once the threaded grip ring is fastened onto the strain relief, the proper amount of force has been applied providing a uniform and controlled connection.

The insulation displacement connections are designed for wire sizes 18 — 14 AWG (1 — 2.5 mm<sup>2</sup>) for the 16-Amp versions and 14 — 10 AWG (2.5 mm<sup>2</sup> — 6 mm<sup>2</sup>) for the 32-Amp versions and are suitable for use under extreme conditions such as heavy vibration.





Distributor ring:  
To accept 5 wires

IDC terminals:  
Automatic connection gives constant, permanent contact pressure

Snap-fit back and front:  
totally secure - only unlocks with screwdriver

Automatic cable gland:  
the absolutely safe solution

### ORDERING INFORMATION

				Male Plug	Female Connector
Amps	No. of Wires	Voltage AC	Clock Position of Ground Contact		
16	3P + N + G	400	6	210SL	310SL
32	3P + N + G	400	6	230SL	330SL

Consult customer service for other amperage and voltage ratings and configurations.



Remove approx. 35 - 40 mm of the sheathing from the cable (with 6 mm<sup>2</sup> 45 mm) and feed it through the back part from behind. Cut off the non-conductive core.



Then lead all five conductors through the distributor ring. Draw one after the other conductor sideways into the marked connection chambers. No stripping required.



Fit distributor ring onto front part. Important: Aligning nose provides for correct position when inserted in guide groove.



Fit back part onto front part and turn until parts lock in place automatically.



Finally tighten the cable gland (torque at least 4 Nm) - ready.



To disassemble first unscrew the cable gland (a). Then press the screwdriver (blade width 3.0 mm) deeply into the opening slot of the back part. Turn screwdriver clockwise to unlock the parts again.

# POWER plus CONTROL = **CEEpro**

Walther's advanced series of CEEpro connectors combine both power and control, monitoring and sensing contacts in one plug and socket system.



For more information call customer service at **(800) 925-8437**

## Example: Part Number 269419

<b>2</b>	<b>6</b>	<b>9</b>	<b>4</b>	<b>19</b>
<b>Device Type 1st Digit</b>	<b>Amperage Rating 2nd Digit</b>	<b>Versions (Environmental) 3rd Digit</b>	<b>Poles and Wires 4th Digit</b>	<b>Clock Position 5th &amp; 6th Digit</b>
1= Female Socket-Outlet (Surface (Mount))	1= 20A North American 16A International  3= 30A North American 32A International	0= One top entry (splashproof)  1= Three entries (splashproof)  9= Three entries (Watertight)	3= 2 Pole + G or 1 Pole + N + G  4= 3 Pole + G or 2 Pole + N + G	1 Hour = 01 2 Hour = 02 3 Hour = 03 4 Hour = 04 5 Hour = 05 6 Hour = 06
2= Male Plug  3= Female Connector	6= 60A North American 63A International  7= 100A North American 125A International	0= With cable entry boot (splashproof)  1= With strain relief conn. (splashproof)  9= With strain relief conn. (Watertight)	5= 3 Pole + N + G  7= 6 Pole + G	7 Hour = 07 8 Hour = 08 9 Hour = 09 10 Hour = 10 11 Hour = 11 12 Hour = 12
4= Female Receptacle Socket-Outlet (Panel Mount Striaight)		0= Various mounting and 1= Flange sizes 2= (splashproof)		1 Hour = 13 2 Hour = 14 3 Hour = 15
5= Female Receptacle Socket-Outlet (Panel Mount Angled)		4= Two-Piece (spalshproof)		4 Hour = 16 5 Hour = 17 6 Hour = 18
		7= Various mounting and 8= flange sizes 9= (Watertight)		7 Hour = 19 8 Hour = 20 9 Hour = 21
6= Male Inlet (Appliance Plug)		0= Surface Mount Angled (splashproof)  1= Panel Mount Angled (splashproof)  5= Panel Mount Straight (splashproof)  6= Two-Piece (splashproof)  8= Surface Mount (Watertight)  9= Panel Mount (Watertight)		10 Hour = 22 11 Hour = 23 12 Hour = 24

**TABLE 1** Cable and Conductor Strip Length

		Device Rating				
		North American	20A	30A	60A	100A
		International	16A	32A	63A	125A
Outer Jacket Strip Length	inch	2	2 1/2	3	4	
	mm	50	63	76	102	
Conductor Strip Length	inch	1/2	1/2	3/4	1 1/8	
	mm	12	12	19	28	
Pilot Conductor Strip Length	inch			7/16	5/8	
	mm			11	16	

**TABLE 2** Maximum Torque applied to terminal screws

		Device Rating				
		North American	20A	30A	60A	100A
		International	16A	32A	63A	125A
Torque Terminal Screw	lb. - in.	7.1	7.1	17.6	35.3	
	N - m	0.8	0.8	2	4	
Torque Pilot Screw	lb. - in.			7.1	7.1	
	N - m			0.8	0.8	

**TABLE 4** Metric and AWG/MCM conductor size equivalents

Conductor Size		Test Range (Amperage)
mm <sup>2</sup>	AWG/MCM	
1,0	18	0-8
1,5	16	8-12
2,5	14	12-15
2,5	12	15-20
4,0	10	20-25
6,0	10	25-32
10	8	32-50
16	6	50-65
25	4	65-85
35	3	85-100
35	2	100-115
50	1	115-130
50	1/0	130-150
70	2/0	150-175
95	3/0	175-200
95	4/0	200-225
120	250	225-250
150	300	250-275
185	350	275-300
185	400	300-350
240	500	350-400

**TABLE 3** Cable and Conductor Range

Amps	Poles and Wires	From AWG	Type	To AWG	Type	Cord Grip Range					
						With Cable Gland		With Cable Sleeve			
						North American	International	North American	International		
16	20	2P3W	16	S	10	S	inch	0.275 - 0.530	0.275 - 0.530	0.275 - 0.675	0.275 - 0.675
							mm	7 - 13.5	7 - 13.5	7 - 17	7 - 17
							inch	.395 - .825	0.275 - 0.630	0.315 - 0.800	0.315 - 0.800
							mm	10 - 21	7 - 16	8 - 20	8 - 20
							inch	.395 - .825	0.275 - 0.630	0.315 - 0.800	0.315 - 0.800
							mm	10 - 21	7 - 16	8 - 20	8 - 20
30	32	2P3W	12	S	8	S	inch	.395 - .825	.395 - .825	0.590 - 0.950	0.435 - 0.950
							mm	10 - 21	10 - 21	15 - 24	11 - 24
							inch	0.650 - 1.10	.395 - .825	0.590 - 0.950	0.435 - 0.950
							mm	16.5 - 28	10 - 21	15 - 24	11 - 24
							inch	0.650 - 1.10	.395 - .825	0.590 - 0.950	0.435 - 0.950
							mm	16.5 - 28	10 - 21	15 - 24	11 - 24
60*	63*	2P3W	8	S	4	S or W	inch	.650 - 1.50	.650 - 1.50	0.635 - 1.30	0.600 - 1.30
							mm	16.5 - 38	16.5 - 38	16 - 33	15 - 33
							inch	.650 - 1.50	.650 - 1.50	0.635 - 1.30	0.600 - 1.30
							mm	16.5 - 38	16.5 - 38	16 - 33	15 - 33
							inch	.650 - 1.50	.650 - 1.50	0.635 - 1.30	0.600 - 1.30
							mm	16.5 - 38	16.5 - 38	16 - 33	15 - 33
100*	125*	2P3W	6	S or W	2/0	S or W	inch	.950 - 1.90	.950 - 1.90		
							mm	24 - 48	24 - 48		
							inch	.950 - 1.90	.950 - 1.90		
							mm	24 - 48	24 - 48		
							inch	.950 - 1.90	.950 - 1.90		
							mm	24 - 48	24 - 48		

\* Pilot conductor 16 to 8 AWG

# IEC 309 PIN & SLEEVE DEVICES • APPROXIMATE DIMENSIONS

## WATERTIGHT PLUGS (IP67)

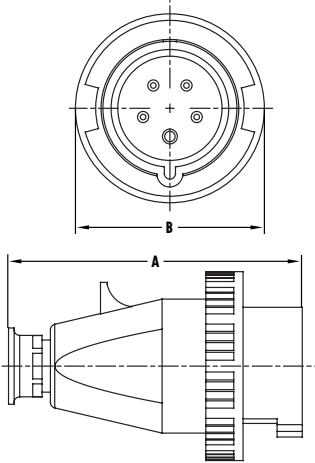

Amps		Type	Dimensions		Cord Grip Range		
N.A.	Intl.		A	B	N. American	International	
20	16	3 Wire	inch	4.96	2.83	0.275 - 0.530	0.275 - 0.530
			mm	126	72	7.0 - 13.5	7.0 - 13.5
20	16	4 Wire	inch	5.20	3.19	0.395 - 0.825	0.275 - 0.630
			mm	132	81	10.0 - 21.0	7.0 - 16.0
20	16	5 Wire	inch	5.20	3.46	0.395 - 0.825	0.275 - 0.630
			mm	132	88	10.0 - 21.0	7.0 - 16.0
30	32	3 Wire	inch	6.14	3.78	0.395 - 0.825	0.395 - 0.825
			mm	156	96	10.0 - 21.0	10.0 - 21.0
30	32	4 Wire	inch	6.14	3.78	0.650 - 1.10	0.395 - 0.825
			mm	156	96	16.5 - 28.0	10.0 - 21.0
30	32	5 Wire	inch	6.14	4.06	0.650 - 1.10	0.395 - 0.825
			mm	156	103	16.5 - 28.0	10.0 - 21.0
60	63	3, 4, & 5 Wire	inch	9.57	4.33	0.650 - 1.50	0.650 - 1.50
			mm	243	110	16.5 - 38.0	16.5 - 38.0
100	125	3, 4, & 5 Wire	inch	12.40	5.12	0.950 - 1.90	0.950 - 1.90
			mm	315	130	24.0 - 48.0	24.0 - 48.0

## SPLASHPROOF PLUGS (IP44) (with cable gland)

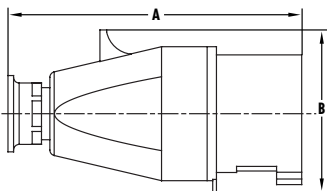

Amps		Type	Dimensions		Cord Grip Range		
N.A.	Intl.		A	B	N. American	International	
20	16	3 Wire	inch	4.84	2.36	0.275 - 0.530	0.275 - 0.530
			mm	123	60	7.0 - 13.5	7.0 - 13.5
20	16	4 Wire	inch	5.16	2.68	0.395 - 0.825	0.275 - 0.630
			mm	131	68	10.0 - 21.0	7.0 - 16.0
20	16	5 & 7 Wire	inch	5.16	2.95	0.395 - 0.825	0.275 - 0.630
			mm	131	75	10.0 - 21.0	7.0 - 16.0
30	32	3 Wire	inch	6.10	3.11	0.395 - 0.825	0.395 - 0.825
			mm	155	79	10.0 - 21.0	10.0 - 21.0
30	32	4 Wire	inch	6.10	3.11	0.650 - 1.10	0.395 - 0.825
			mm	155	79	16.5 - 28.0	10.0 - 21.0
30	32	5 & 7 Wire	inch	6.10	3.46	0.650 - 1.10	0.395 - 0.825
			mm	155	88	16.5 - 28.0	10.0 - 21.0
60	63	3, 4, & 5 Wire	inch	9.45	3.82	0.650 - 1.50	0.650 - 1.50
			mm	240	97	16.5 - 38.0	16.5 - 38.0

## SPLASHPROOF PLUGS (IP44) (with cable sleeve)

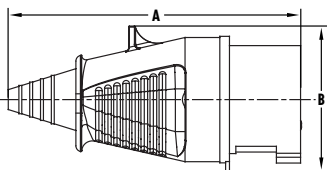

Amps		Type	Dimensions		Cord Grip Range		
N.A.	Intl.		A	B	N. American	International	
20	16	3 Wire	inch	5.63	2.36	0.275 - 0.675	0.275 - 0.675
			mm	143	60	7.0 - 17.0	7.0 - 17.0
20	16	4 Wire	inch	5.79	2.68	0.315 - 0.800	0.315 - 0.800
			mm	147	68	8.0 - 20.0	8.0 - 20.0
20	16	5 & 7 Wire	inch	6.02	2.95	0.315 - 0.800	0.315 - 0.800
			mm	153	75	8.0 - 20.0	8.0 - 20.0
30	32	3 Wire	inch	7.13	3.11	0.590 - 0.950	0.435 - 0.950
			mm	181	79	15.0 - 24.0	11.0 - 24.0
30	32	4 Wire	inch	7.13	3.11	0.590 - 0.950	0.435 - 0.95
			mm	181	79	15.0 - 24.0	11.0 - 24.0
30	32	5 & 7 Wire	inch	7.13	3.46	0.590 - 0.950	0.435 - 0.95
			mm	181	88	15.0 - 24.0	11.0 - 24.0
60	63	3, 4, & 5 Wire	inch	9.92	3.82	0.635 - 1.30	0.600 - 1.30
			mm	252	97	16.0 - 33.0	15.0 - 33.0

# IEC 309 PIN & SLEEVE DEVICES • APPROXIMATE DIMENSIONS

## WATERTIGHT CONNECTORS (IP67)

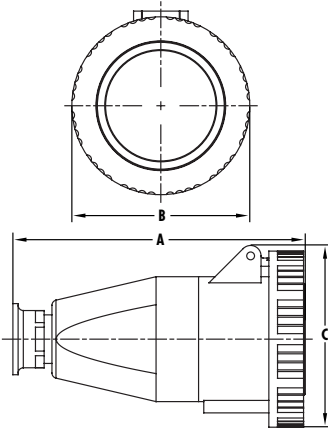

Amps		Type	Dimensions			Cord Grip Range		
N.A.	Intl.		A	B	C	N. American	International	
20	16	3 Wire	inch	5.35	2.83	3.07	0.275 - 0.530	0.275 - 0.530
			mm	136	72	78	7.0 - 13.5	7.0 - 13.5
20	16	4 Wire	inch	5.63	3.19	3.35	0.395 - 0.825	0.275 - 0.630
			mm	143	81	85	10.0 - 21.0	7.0 - 16.0
20	16	5 Wire	inch	5.63	3.46	3.58	0.395 - 0.825	0.275 - 0.630
			mm	143	88	91	10.0 - 21.0	7.0 - 16.0
30	32	3 Wire	inch	6.97	3.78	3.78	0.395 - 0.825	0.395 - 0.825
			mm	177	96	96	10.0 - 21.0	10.0 - 21.0
30	32	4 Wire	inch	6.97	3.78	3.78	0.650 - 1.10	0.395 - 0.825
			mm	177	96	96	16.5 - 28.0	10.0 - 21.0
30	32	5 Wire	inch	6.97	4.06	4.13	0.650 - 1.10	0.395 - 0.825
			mm	177	103	105	16.5 - 28.0	10.0 - 21.0
60	63	3, 4, & 5 Wire	inch	10.0	4.33	4.61	0.650 - 1.50	0.650 - 1.50
			mm	255	110	117	16.5 - 38.0	16.5 - 38.0
100	125	3, 4, & 5 Wire	inch	13.1	5.12	5.12	0.950 - 1.90	0.950 - 1.90
			mm	332	130	130	24.0 - 48.0	24.0 - 48.0

## SPLASHPROOF CONNECTORS (IP44) (with cable gland)

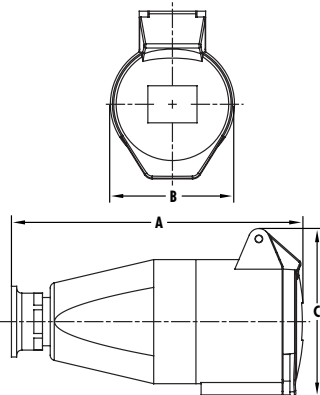

Amps		Type	Dimensions			Cord Grip Range		
N.A.	Intl.		A	B	C	N. American	International	
20	16	3 Wire	inch	5.32	2.01	2.68	0.275 - 0.530	0.275 - 0.530
			mm	135	51	68	7.0 - 13.5	7.0 - 13.5
20	16	4 Wire	inch	5.95	2.56	3.35	0.395 - 0.825	0.275 - 0.630
			mm	151	65	85	10.0 - 21.0	7.0 - 16.0
20	16	5 & 7 Wire	inch	5.95	2.56	3.35	0.395 - 0.825	0.275 - 0.630
			mm	151	65	85	10.0 - 21.0	7.0 - 16.0
30	32	3 Wire	inch	6.73	2.83	3.58	0.395 - 0.825	0.395 - 0.825
			mm	171	72	91	10.0 - 21.0	10.0 - 21.0
30	32	4 Wire	inch	6.73	2.83	3.58	0.650 - 1.10	0.395 - 0.825
			mm	171	72	91	16.5 - 28.0	10.0 - 21.0
30	32	5 & 7 Wire	inch	6.73	2.83	3.86	0.650 - 1.10	0.395 - 0.825
			mm	171	72	98	16.5 - 28.0	10.0 - 21.0
60	63	3, 4, & 5 Wire	inch	10.0	3.78	4.49	0.650 - 1.50	0.650 - 1.50
			mm	255	96	114	16.5 - 38.0	16.5 - 38.0

## SPLASHPROOF CONNECTORS (IP44) (with cable sleeve)

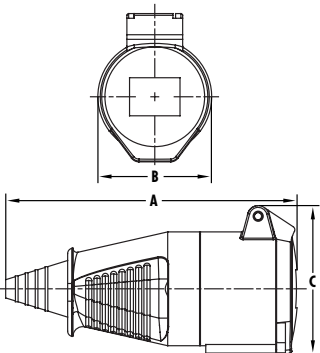

Amps		Type	Dimensions			Cord Grip Range		
N.A.	Intl.		A	B	C	N. American	International	
20	16	3 Wire	inch	6.06	2.01	2.69	0.275 - 0.675	0.275 - 0.675
			mm	154	51	68.4	7.0 - 17.0	7.0 - 17.0
20	16	4 Wire	inch	6.54	2.56	2.97	0.315 - 0.800	0.315 - 0.800
			mm	166	65	75.4	8.0 - 20.0	8.0 - 20.0
20	16	5 & 7 Wire	inch	6.54	2.56	3.29	0.315 - 0.800	0.315 - 0.800
			mm	166	65	83.5	8.0 - 20.0	8.0 - 20.0
30	32	3 Wire	inch	7.72	2.83	3.54	0.590 - 0.950	0.435 - 0.950
			mm	196	72	90	15.0 - 24.0	11.0 - 24.0
30	32	4 Wire	inch	7.72	2.83	3.54	0.590 - 0.950	0.435 - 0.95
			mm	196	72	90	15.0 - 24.0	11.0 - 24.0
30	32	5 & 7 Wire	inch	7.72	2.83	3.78	0.590 - 0.950	0.435 - 0.95
			mm	196	72	96	15.0 - 24.0	11.0 - 24.0
60	63	3, 4, & 5 Wire	inch	10.5	3.78	4.41	0.635 - 1.30	0.600 - 1.30
			mm	266	96	112	16.0 - 33.0	15.0 - 33.0

## WATERTIGHT RECEPTACLE (IP67) (Straight)

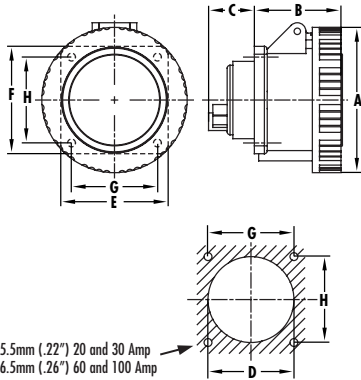

Amps	N.A.	Intl.	Type	Dimensions							
				A	B	C	D	E	F	G	H
20	16	3 Wire	inch	2.82	2.05	1.10	1.81	2.44	2.44	1.85	1.85
			mm	71.5	52	28	46	62	62	47	47
20	16	4 Wire	inch	31.9	2.05	1.10	2.36	2.95	2.95	2.36	2.36
			mm	81	52	28	60	75	75	60	60
20	16	5 Wire	inch	3.46	2.05	1.10	2.36	2.95	2.95	2.36	2.36
			mm	88	52	28	60	75	75	60	60
30	32	3 & 4 Wire	inch	3.78	2.56	1.06	2.36	2.95	2.95	2.36	2.36
			mm	96	65	27	60	75	75	60	60
30	32	5 Wire	inch	4.06	2.56	1.06	2.36	2.95	2.95	2.36	2.36
			mm	103	65	27	60	75	75	60	60
60	63	3, 4, & 5 Wire	inch	4.29	3.27	2.05	3.54	3.94	4.21	3.03	3.35
			mm	109	83	52	90	100	107	77	85
100	125	3, 4, & 5 Wire	inch	5.12	3.78	2.52	3.54	4.49	4.49	3.54	3.54
			mm	130	96	64	90	114	114	90	90

## WATERTIGHT RECEPTACLE (IP67) (Angled 15°)

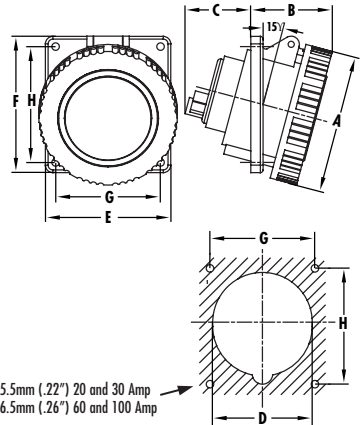

Amps	N.A.	Intl.	Type	Dimensions							
				A	B	C	D	E	F	G	H
20	16	3 Wire	inch	2.82	1.93	1.61	2.01	2.44	2.68	1.85	1.85
			mm	71.5	49	41	51	62	68	47	47
20	16	4 Wire	inch	3.19	2.05	1.50	2.87	3.62	3.94	3.03	3.35
			mm	81	52	38	73	92	100	77	85
20	16	5 Wire	inch	3.46	2.05	1.50	2.87	3.62	3.94	3.03	3.35
			mm	88	52	38	73	92	100	77	85
30	32	3 & 4 Wire	inch	3.78	2.20	1.85	2.87	3.62	3.94	3.03	3.35
			mm	96	56	47	73	92	100	77	85
30	32	5 Wire	inch	4.06	2.36	1.85	2.87	3.62	3.94	3.03	3.35
			mm	103	60	47	73	92	100	77	85
60	63	3, 4, & 5 Wire	inch	4.29	3.23	2.52	3.19	3.94	4.21	3.03	3.35
			mm	109	82	64	81	100	107	77	85
100	125	3, 4, & 5 Wire	inch	5.12	3.70	2.95	3.54	4.49	4.49	3.54	3.54
			mm	130	94	75	90	114	114	90	90

## WATERTIGHT RECEPTACLE (IP67) (Angled 80°)

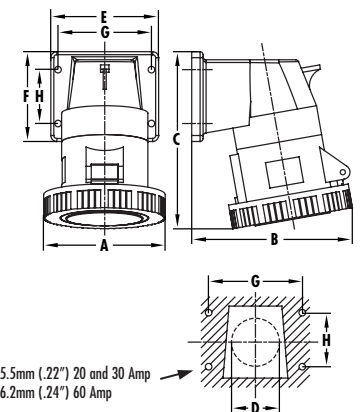

Amps	N.A.	Intl.	Type	Dimensions							
				A	B	C	D max	E	F	G	H
20	16	3 Wire	inch	2.83	3.46	4.29	1.18	2.56	2.05	2.17	1.18
			mm	72	88	109	30	65	52	55	30
20	16	4 Wire	inch	3.19	4.25	4.84	1.50	3.15	2.60	2.68	1.57
			mm	81	108	123	38	80	66	68	40
20	16	5 Wire	inch	3.46	4.25	4.84	1.50	3.15	2.60	2.68	1.57
			mm	88	108	123	38	80	66	68	40
30	32	3 & 4 Wire	inch	3.78	4.76	5.71	1.73	3.54	2.95	3.07	1.77
			mm	96	121	145	44	90	75	78	45
30	32	5 Wire	inch	4.06	4.84	5.71	1.73	3.54	2.95	3.07	1.77
			mm	103	123	145	44	90	75	78	45
60	63	3, 4, & 5 Wire	inch	4.33	5.63	7.99	2.20	4.49	4.49	3.54	3.54
			mm	110	143	203	56	114	114	90	90



## SPLASHPROOF RECEPTACLES (IP44) (Straight)

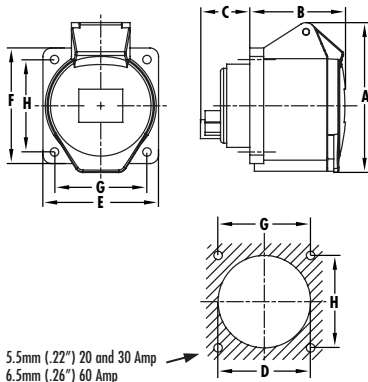

Amps		Type	Dimensions								
N.A.	Intl.		A	B	C	D	E	F	G	H	
20	16	3 Wire	inch	2.68	2.05	1.10	1.81	2.44	2.44	1.85	1.85
			mm	68	52	28	46	62	62	47	47
20	16	4 & 5 Wire	inch	3.35	2.09	1.10	2.36	2.95	2.95	2.36	2.36
			mm	85	53	28	60	75	75	60	60
20	16	7 Wire	inch	3.35	2.09	1.10	2.36	3.15	3.15	2.36	2.36
			mm	85	53	28	60	80	80	60	60
30	32	3 & 4 Wire	inch	3.58	2.56	1.06	2.36	2.95	2.95	2.36	2.36
			mm	91	65	27	60	75	75	60	60
30	32	5 Wire	inch	3.86	2.56	1.06	2.36	2.95	2.95	2.36	2.36
			mm	98	65	27	60	75	75	60	60
30	32	7 Wire	inch	3.86	2.56	1.06	2.36	3.15	3.15	2.36	2.36
			mm	98	65	27	60	80	80	60	60
60	63	3, 4, & 5 Wire	inch	4.49	3.35	2.05	3.54	3.94	4.21	3.03	3.35
			mm	114	85	52	90	100	107	77	85

## SPLASHPROOF RECEPTACLE (IP44) (Angled 15°)

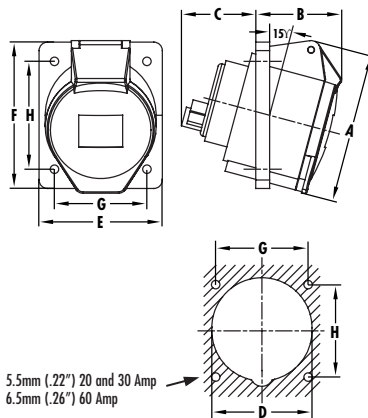

Amps		Type	Dimensions								
N.A.	Intl.		A	B	C	D	E	F	G	H	
20	16	3 Wire	inch	2.68	1.77	1.61	2.01	2.44	2.68	1.85	1.85
			mm	68	45	41	51	62	68	47	47
20	16	4 Wire	inch	3.35	2.01	1.50	2.36	2.95	2.95	2.36	2.36
			mm	85	51	38	60	75	75	60	60
20	16	5 Wire	inch	3.35	2.01	1.50	2.56	2.95	3.35	2.36	2.36
			mm	85	51	38	65	75	85	60	60
30	32	3 Wire	inch	3.58	2.05	1.85	2.64	2.95	3.54	2.36	2.36
			mm	91	52	47	67	75	90	60	60
30	32	4 Wire	inch	3.85	2.05	1.85	2.64	2.95	3.54	2.36	2.36
			mm	91	52	47	67	75	90	60	60
30	32	5 Wire	inch	3.86	2.20	1.85	2.70	3.15	3.74	2.36	2.36
			mm	98	56	47	68.5	80	95	60	60
60	63	3, 4, & 5 Wire	inch		3.11	2.52	3.19	3.94	4.21	3.03	3.35
			mm		79	64	81	100	107	77	85

## SPLASHPROOF RECEPTACLE (IP44) (Angled 80°)

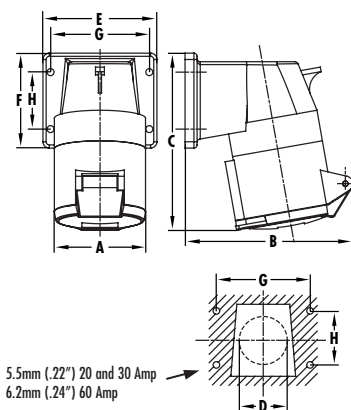

Amps		Type	Dimensions								
N.A.	Intl.		A	B	C	D max	E	F	G	H	
20	16	3 Wire	inch	2.01	3.43	4.57	1.18	2.56	2.05	2.17	1.18
			mm	51	87	116	30	65	52	55	30
20	16	4 Wire	inch	2.56	4.33	4.80	1.50	3.15	2.60	2.68	1.57
			mm	65	110	122	38	80	66	68	40
20	16	5 & 7 Wire	inch	2.56	4.33	4.80	1.50	3.15	2.60	2.68	1.57
			mm	65	110	122	38	80	66	68	40
30	32	3 Wire	inch	2.83	4.72	5.55	1.73	3.54	2.95	3.07	1.77
			mm	72	120	141	44	90	75	78	45
30	32	4 Wire	inch	2.83	4.72	5.55	1.73	3.54	2.95	3.07	1.77
			mm	72	120	141	44	90	75	78	45
30	32	5 & 7 Wire	inch	2.83	4.88	5.59	1.73	3.54	2.95	3.07	1.77
			mm	72	124	142	44	90	75	78	45
60	63	3, 4, & 5 Wire	inch	3.78	5.51	7.64	2.20	4.49	4.49	3.54	3.54
			mm	96	140	194	56	114	114	90	90

# IEC 309 PIN & SLEEVE DEVICES • APPROXIMATE DIMENSIONS

## WATERTIGHT INLETS (IP67) (Straight)

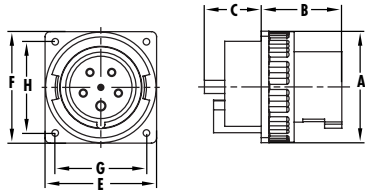

6.5mm (.26") 60 and 100 Amp

Amps		Type	Dimensions										
N.A.	Intl.		A	B	C	D	E	F	G	H			
100	125	3 Wire	inch	5.12	3.70	2.20	3.54	5.12	5.12	4.09	4.09		
			mm	130	94	56	90	130	130	104	104		
100	125	4 Wire	inch	5.12	3.70	2.20	3.54	5.12	5.12	4.09	4.09		
			mm	130	94	56	90	130	130	104	104		
100	125	5 Wire	inch	5.12	3.70	2.20	3.54	5.12	5.12	4.09	4.09		
			mm	130	94	56	90	130	130	104	104		

## WATERTIGHT INLETS (IP67) (Angled 80°)

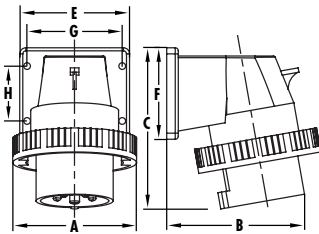

5.5mm (.22") 20 and 30 Amp  
6.2mm (.24") 60 and 100 Amp

Amps		Type	Dimensions										
N.A.	Intl.		A	B	C	D (max)	E	F	G	H			
20	16	3 Wire	inch	2.83	3.19	3.86	1.18	2.56	2.05	2.17	1.18		
			mm	72	81	98	30	65	52	55	30		
20	16	4 Wire	inch	3.19	3.90	4.33	1.50	3.15	2.60	2.68	1.57		
			mm	81	99	110	38	80	66	68	40		
20	16	5 Wire	inch	3.50	4.06	4.45	1.50	3.15	2.60	2.68	1.57		
			mm	89	103	113	38	80	66	68	40		
30	32	3 Wire	inch	3.78	4.45	5.12	1.73	3.54	2.95	3.07	1.77		
			mm	96	113	130	44	90	75	78	45		
30	32	4 Wire	inch	3.78	4.45	5.12	1.73	3.54	2.95	3.07	1.77		
			mm	96	113	130	44	90	75	78	45		
30	32	5 Wire	inch	4.02	4.61	5.12	1.73	3.54	2.95	3.07	1.77		
			mm	102	117	130	44	90	75	78	45		
60	63	3, 4, & 5 Wire	inch	4.33	5.00	7.20	2.20	4.49	4.49	3.54	3.54		
			mm	110	127	183	56	114	114	90	90		

## WATERTIGHT INLETS (IP67) (Surface Mount, Angled 80°)

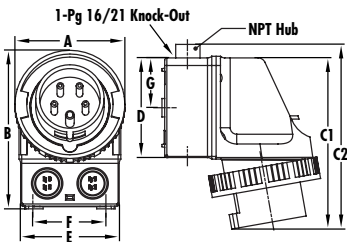

Amps		Type	Dimensions								Hub Size*	
N.A.	Intl.		A	B	C <sup>1</sup>	C <sup>2</sup>	D	E	F	G		
20	16	3 Wire	inch	2.83	5.51	6.06	6.73	3.78	3.74	2.62	1.87	3/4"
			mm	72	140	154	171	96	95	66.5	47.5	
20	16	4 Wire	inch	3.19	5.51	6.06	6.73	3.78	3.74	2.62	1.87	3/4"
			mm	81	140	154	171	96	95	66.5	47.5	
20	16	5 Wire	inch	3.46	5.51	6.06	6.73	3.78	3.74	2.62	1.87	3/4"
			mm	88	140	154	171	96	95	66.5	47.5	
30	32	3 Wire	inch	3.78	5.79	6.46	7.13	3.78	3.74	2.62	1.87	3/4"
			mm	96	147	164	181	96	95	66.5	47.5	
30	32	4 Wire	inch	3.78	5.79	6.46	7.13	3.78	3.74	2.62	1.87	3/4"
			mm	96	147	164	181	96	95	66.5	47.5	
30	32	5 Wire	inch	4.06	5.91	6.46	7.13	3.78	3.74	2.62	1.87	3/4"
			mm	103	150	164	181	96	95	66.5	47.5	

## SPLASHPROOF INLETS (IP44) (Straight)

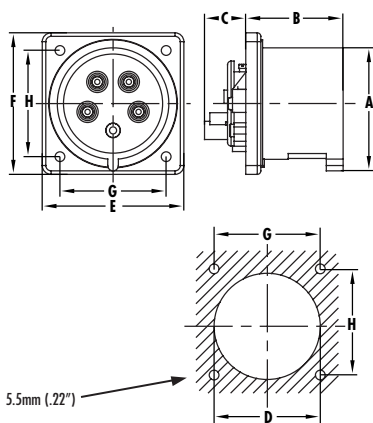

Amps			Dimensions								
N.A.	Intl.	Type	A	B	C	D	E	F	G	H	
20	16	3 Wire	inch	1.85	1.85	0.87	1.97	2.44	2.44	1.85	1.85
			mm	47	47	22	50	62	62	47	47
20	16	4 Wire	inch	2.09	1.85	0.87	2.64	3.15	3.15	2.36	2.36
			mm	53	47	22	67	80	80	60	60
20	16	5 & 7 Wire	inch	2.40	1.85	0.87	2.64	3.15	3.15	2.36	2.36
			mm	61	47	22	67	80	80	60	60
30	32	3 Wire	inch	2.48	2.20	0.87	2.80	3.15	3.15	2.36	2.36
			mm	63	56	22	71	80	80	60	60
30	32	4 Wire	inch	2.48	2.20	0.87	2.80	3.15	3.15	2.36	2.36
			mm	63	56	22	71	80	80	60	60
30	32	5 & 7 Wire	inch	2.72	2.20	0.87	2.80	3.15	3.15	2.36	2.36
			mm	69	56	22	71	80	80	60	60
60	63	5 Wire	inch	2.99	3.27	1.14	3.39	4.17	4.33	3.54	3.54
			mm	76	83	29	86	106	110	90	90

## SPLASHPROOF INLETS (IP44) (Angled 80°)

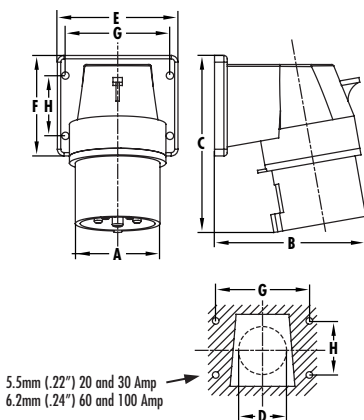

Amps			Dimensions								
N.A.	Intl.	Type	A	B	C	D (max)	E	F	G	H	
20	16	3 Wire	inch	1.71	2.83	3.82	1.18	2.56	2.05	2.17	1.18
			mm	43.5	72	97	30	65	52	55	30
20	16	4 Wire	inch	1.97	3.54	4.33	1.50	3.15	2.60	2.68	1.57
			mm	50	90	110	38	80	66	68	40
20	16	5 & 7 Wire	inch	2.20	3.62	4.33	1.50	3.15	2.60	2.68	1.57
			mm	56	92	110	38	80	66	68	40
30	32	3 Wire	inch	2.24	4.06	5.08	1.73	3.54	2.95	3.07	1.77
			mm	57	103	129	44	90	75	78	45
30	32	4 Wire	inch	2.24	4.06	5.08	1.73	3.54	2.95	3.07	1.77
			mm	57	103	129	44	90	75	78	45
30	32	5 & 7 Wire	inch	2.52	4.06	5.08	1.73	3.54	2.95	3.07	1.77
			mm	64	103	129	44	90	75	78	45
60	63	3, 4, & 5 Wire	inch	2.72	4.57	7.28	2.20	4.49	4.49	3.54	3.54
			mm	69	116	185	56	114	114	90	90

## SPLASHPROOF INLETS (IP44) (Surface Mount, Angled 80°)

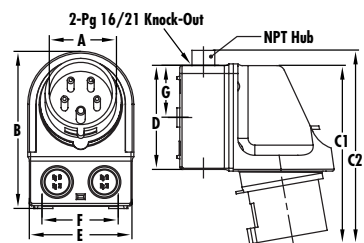

Amps			Dimensions									Hub Size*
N.A.	Intl.	Type	A	B	C <sup>1</sup>	C <sup>2</sup>	D	E	F	G		
20	16	4 Wire	inch	1.97	5.51	5.95	6.61	3.78	3.74	2.62	1.87	3/4"
			mm	50	140	151	168	96	95	66.5	47.5	
20	16	5 & 7 Wire	inch	2.20	5.51	5.95	6.61	3.78	3.74	2.62	1.87	3/4"
			mm	56	140	151	168	96	95	66.5	47.5	
30	32	3 Wire	inch	2.24	5.51	6.30	6.97	3.78	3.74	2.62	1.87	3/4"
			mm	57	140	160	177	96	95	66.5	47.5	
30	32	4 Wire	inch	2.24	5.51	6.30	6.97	3.78	3.74	2.62	1.87	3/4"
			mm	57	140	160	177	96	95	66.5	47.5	
30	32	5 & 7 Wire	inch	2.52	5.51	6.30	6.97	3.78	3.74	2.62	1.87	3/4"
			mm	64	140	160	177	96	95	66.5	47.5	

## WATERTIGHT RECEPTACLES (IP67) (Surface Mount, Angled 80°)

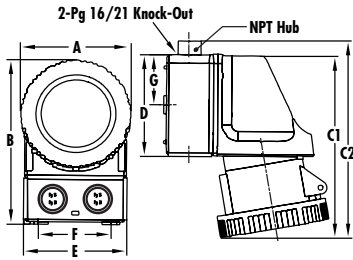

Amps		Type	Dimensions									Hub Size*
N.A.	Intl.		A	B	C <sup>1</sup>	C <sup>2</sup>	D	E	F	G		
20	16	3 Wire	inch	2.83	5.51	6.46	7.13	3.78	3.74	2.62	1.87	3/4"
			mm	72	140	164	181	96	95	66.5	47.5	
		4 Wire	inch	3.19	5.67	6.46	7.13	3.78	3.74	2.62	1.87	3/4"
			mm	81	144	164	181	96	95	66.5	47.5	
		5 Wire	inch	3.46	5.79	6.46	7.13	3.78	3.74	2.62	1.87	3/4"
			mm	88	147	164	181	96	95	66.5	47.5	
30	32	3 Wire	inch	3.78	6.06	6.93	7.60	3.78	3.74	2.62	1.87	3/4"
			mm	96	154	176	193	96	95	66.5	47.5	
		4 Wire	inch	3.78	6.06	6.93	7.60	3.78	3.74	2.62	1.87	3/4"
			mm	96	154	176	193	96	95	66.5	47.5	
		5 Wire	inch	4.06	6.14	6.93	7.60	3.78	3.74	2.62	1.87	3/4"
			mm	103	156	176	193	96	95	66.5	47.5	

## WATERTIGHT RECEPTACLES (IP67) (Surface Mount, Angled 80°)

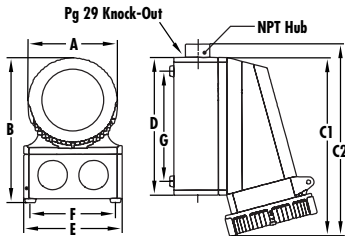

Amps		Type	Dimensions									Hub Size*
N.A.	Intl.		A	B	C <sup>1</sup>	C <sup>2</sup>	D	E	F	G		
60	63	4 Wire	inch	4.33	7.01	8.82	9.76	6.77	4.76	4.09	5.35	1 1/4"
			mm	110	178	224	248	172	121	104	136	
		5 Wire	inch	4.33	7.01	8.82	9.76	6.77	4.76	4.09	5.35	1 1/4"
			mm	110	178	224	248	172	121	104	136	

## WATERTIGHT RECEPTACLES (IP67) (Surface Mount, Angled 80°)

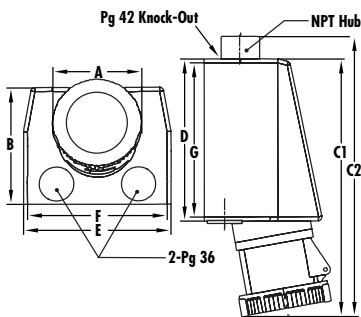

Amps		Type	Dimensions									Hub Size*
N.A.	Intl.		A	B	C <sup>1</sup>	C <sup>2</sup>	D	E	F	G		
100	125	3 Wire	inch	5.12	7.48	16.0	16.9	10.4	8.66	7.87	9.45	2"
			mm	130	190	406	430	263	220	200	240	
		4 Wire	inch	5.12	7.48	16.0	16.9	10.4	8.66	7.87	9.45	2"
			mm	130	190	406	430	263	220	200	240	
		5 Wire	inch	5.12	7.48	16.0	16.9	10.4	8.66	7.87	9.45	2"
			mm	130	190	406	430	263	220	200	240	

# IEC 309 PIN & SLEEVE DEVICES • APPROXIMATE DIMENSIONS

## SPLASHPROOF RECEPTACLES (IP44) (Surface Mount, Angled 80°)

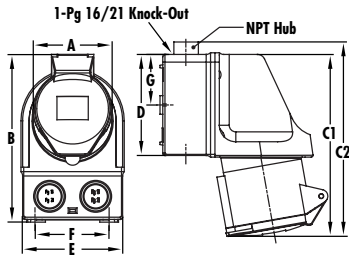

Amps		Type	Dimensions										Hub Size*
N.A.	Intl.		A	B	C <sup>1</sup>	C <sup>2</sup>	D	E	F	G			
20	16	3 Wire	inch	2.01	5.51	6.30	6.97	3.78	3.74	2.62	1.87	3/4"	
			mm	51	140	160	177	96	95	66.5	47.5		
20	16	4 Wire	inch	2.56	5.63	6.46	7.13	3.78	3.74	2.62	1.87	3/4"	
			mm	65	143	164	181	96	95	66.5	47.5		
20	16	5 & 7 Wire	inch	2.56	5.75	6.46	7.13	3.78	3.74	2.62	1.87	3/4"	
			mm	65	146	164	181	96	95	66.5	47.5		
30	32	3 Wire	inch	2.83	6.06	6.81	7.48	3.78	3.74	2.62	1.87	3/4"	
			mm	72	154	173	190	96	95	66.5	47.5		
30	32	4 Wire	inch	2.83	6.06	6.81	7.48	3.78	3.74	2.62	1.87	3/4"	
			mm	72	154	173	190	96	95	66.5	47.5		
30	32	5 & 7 Wire	inch	2.83	6.18	6.81	7.48	3.78	3.74	2.62	1.87	3/4"	
			mm	72	157	173	190	96	95	66.5	47.5		

## SPLASHPROOF RECEPTACLES (IP44) (Surface Mount, Angled 80°)

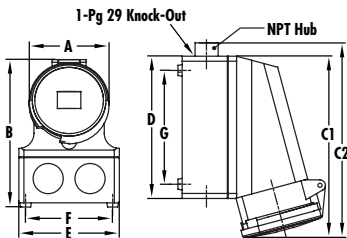

Amps		Type	Dimensions										Hub Size*
N.A.	Intl.		A	B	C <sup>1</sup>	C <sup>2</sup>	D	E	F	G			
60	63	4 Wire	inch	3.78	7.01	8.66	9.61	6.77	4.76	4.09	5.35	1 1/4"	
			mm	96	178	220	244	172	121	104	136		
60	63	5 Wire	inch	3.78	7.01	8.66	9.61	6.77	4.76	4.09	5.35	1 1/4"	
			mm	96	178	220	244	172	121	104	136		



Need a specific print? Call us, we can help!

# IEC 309 PIN & SLEEVE DEVICES • APPROXIMATE DIMENSIONS

## WATERTIGHT INLET (IP67) (Surface Mount, Angled 80°)

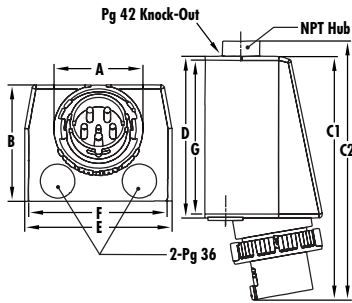

Amps		Type	Dimensions									Hub Size*
N.A.	Intl.		A	B	C <sup>1</sup>	C <sup>2</sup>	D	E	F	G		
60	63	3 Wire	inch	4.33	4.65	9.13	10.1	5.98	4.65	4.17	4.72	1 1/4"
			mm	110	118	232	256	152	118	106	120	
60	63	4 Wire	inch	4.33	4.65	9.13	10.1	5.98	4.65	4.17	4.72	1 1/4"
			mm	110	118	232	256	152	118	106	120	
60	63	5 Wire	inch	4.33	4.65	9.13	10.1	5.98	4.65	4.17	4.72	1 1/4"
			mm	110	118	232	256	152	118	106	120	
100	125	3 Wire	inch	5.12	6.89	15.4	16.3	10.4	8.66	7.87	9.45	2"
			mm	130	175	390	414	263	220	200	240	
100	125	4 Wire	inch	5.12	6.89	15.4	16.3	10.4	8.66	7.87	9.45	2"
			mm	130	175	390	414	263	220	200	240	
100	125	5 Wire	inch	5.12	6.89	15.4	16.3	10.4	8.66	7.87	9.45	2"
			mm	130	175	390	414	263	220	200	240	

Note: Two (2) PG36 knock-outs are on the bottom of the 100/125 amp device only.

## SPLASHPROOF INLET (IP44) (Surface Mount, Angled 80°)

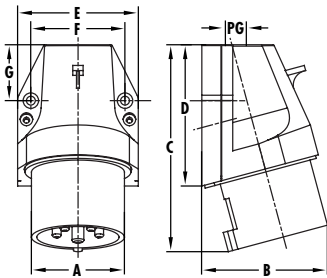

Amps		Type	Dimensions							PG
N.A.	Intl.		A	B	C	D	E	F	G	
16	3 Wire	inch	1.71	2.36	4.33	2.91	2.36	1.79	1.10	
		mm	43.5	60	110	74	60	45.5	28	
16	4 Wire	inch	1.97	2.87	4.61	3.15	2.91	2.36	1.22	
		mm	50	73	117	80	74	60	31	
16	5 & 7 Wire	inch	2.20	2.87	4.61	3.15	2.91	2.36	1.22	
		mm	56	73	117	80	74	60	31	
32	3 Wire	inch	2.24	3.15	5.55	3.82	3.23	2.36	1.77	
		mm	57	80	141	97	82	60	45	
32	4 Wire	inch	2.24	3.15	5.55	3.82	3.23	2.36	1.77	
		mm	57	80	141	97	82	60	45	
32	5 & 7 Wire	inch	2.52	3.39	5.55	3.82	3.23	2.36	1.77	
		mm	64	86	141	97	82	60	45	

## SPLASHPROOF RECEPTACLE (IP44) (Surface Mount, Angled 80°)

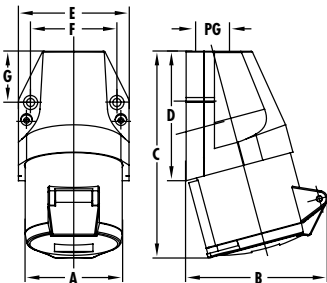

Amps		Type	Dimensions							PG
N.A.	Intl.		A	B	C	D	E	F	G	
16	3 Wire	inch	2.68	2.95	4.72	2.91	2.36	1.79	1.10	
		mm	68	75	120	74	60	45.5	28	
16	4 Wire	inch	3.35	3.39	5.04	3.15	2.91	2.36	1.22	
		mm	85	86	128	80	74	60	31	
16	5 & 7 Wire	inch	3.35	3.54	5.08	3.15	2.91	2.36	1.22	
		mm	85	90	129	80	74	60	31	
32	3 Wire	inch	3.58	4.06	6.06	3.82	3.23	2.36	1.77	
		mm	91	103	154	97	82	60	45	
32	4 Wire	inch	3.58	4.06	6.06	3.82	3.23	2.36	1.77	
		mm	91	103	154	97	82	60	45	
32	5 & 7 Wire	inch	3.86	4.13	6.10	3.82	3.23	2.36	1.77	
		mm	98	105	155	97	82	60	45	

## SPLASHPROOF PLUG (IP44) (Angled)

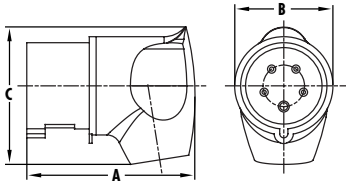

Amps		Type		Dimensions			Cord Grip Range
N.A.	Intl.			A	B	C	
20	16	3 Wire	inch	3.31	1.98	2.66	0.315 - 0.590
			mm	84	50.3	67.5	
20	16	4 Wire	inch	3.98	2.53	3.32	0.395 - 0.650
			mm	101	64.3	84.2	
20	16	5 Wire	inch	3.98	2.53	3.39	0.395 - 0.650
			mm	101	64.3	86	
30	32	3 Wire	inch	4.53	2.83	3.76	0.435 - 0.865
			mm	115	72	95.5	
30	32	4 Wire	inch	4.53	2.83	3.76	0.435 - 0.865
			mm	115	72	95.5	
30	32	5 Wire	inch	4.53	2.83	3.96	0.435 - 0.865
			mm	115	72	100.5	

## SPLASHPROOF CONNECTOR (IP44) (Angled)

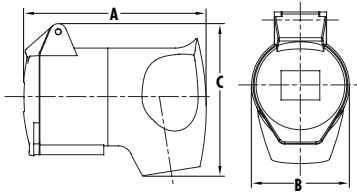

Amps		Type		Dimensions			Cord Grip Range
N.A.	Intl.			A	B	C	
20	16	3 Wire	inch	3.74	1.98	3.15	0.315 - 0.510
			mm	95	50.3	80	



Precision manufacturing aided by C.N.C. technology.

# WORLDWIDE INTERCHANGEABILITY, SAFETY AND RELIABILITY...



## SAFETY

Designed to combine a disconnect switch and a receptacle into one compact device. Walther's mechanical interlock receptacles eliminate the possibility of making or breaking the circuit under load or making a haphazard connection.

A mechanism within the enclosure prevents the switch from being turned to the "ON" position until the plug is fully engaged into the receptacle. Once inserted, the plug is locked in place when the switch is turned on and can't be removed until the switch is turned to the "OFF" position. This prevents making or breaking the circuit under load.

The integration of the switch and the receptacle in a single, compact enclosure encourages the safe operating practice of disconnecting at the switch rather than the plug and receptacle.

The nonmetallic enclosure, while abuse and corrosion resistant, is also non conductive, which enhances the safety of the product. The device can be connected to metallic conduit without interfering with the ground continuity. All mechanical interlock receptacles provide lockout protection for greater safety and comply with OSHA Lockout/Tagout requirements.

## RELIABILITY

These horsepower rated devices are available in both splashproof and watertight versions.

NEMA 4X Watertight (IP67) devices are designed for the most demanding environments and provide protection against corrosion, dirt, dust, splashing water and hose-directed water.

Splashproof (IP44) devices provide many of the heavy-duty construction features found in the watertight devices, but at a more economical cost. These units are suitable and recommended for use in a variety of light industrial environments and provide protection against damaging deposits of dirt and dust, rain and splashing water.

Watertight and splashproof devices provide exceptional UV stability for superior outdoor performance.

## WORLDWIDE INTERCHANGEABILITY

Walther's mechanical interlock receptacles are built to IEC 309-1 and 309-2 specifications and are completely compatible with not only Walther IEC 309-2 plugs, but with any manufacturer's plugs that conform to these IEC standards and color coding system...anywhere in the world.



Walther Mechanical Interlocks, with built-in circuit breakers, incorporate an interlocking receptacle with MCB Type "C" circuit breakers in a non-metallic enclosure that meets Type 4X (Washdown, Corrosion Resistant) requirements.

This new design combines the circuit breakers, switch and receptacle in a single enclosure. The Type "C" circuit breakers are mounted on DIN rail directly above the switch.



## Walther CIRCUIT-BREAKER Mechanical Interlocks

The new CIRCUIT-BREAKER Mechanical Interlock integrates a circuit breaker (which takes the place of a switch) and receptacle in a nonmetallic enclosure that meets Type 4X (Washdown, Corrosion Resistant) requirements.

- Switched, Circuit Breaker Interlock Receptacles are available in 20, 30, 60 and 100 Amp (North American Ratings) and 16, 32, 63 and 125 Amp (International Ratings).
- UL489 Listed 22KAIC protection.



# IEC 309-1 and 309-2 MECHANICAL INTERLOCKS

## Compliance with OSHA Lockout Requirements

Walther's Mechanical Interlock's bright red handle can be locked in the "OFF" position as a method of compliance with OSHA lockout requirements. The handle can accept up to a 5/16" padlock shaft.

## Watertight NEMA 4X, 12K Enclosure

Walther's Mechanical Interlocks are gasketed and rated as a Watertight NEMA 4X, 12K enclosure. The nonmetallic enclosure, while abuse and corrosion resistant, is also non-conductive which enhances the safety of the product.

## Grounding Plate

Walther's Mechanical Interlocks are supplied with a free floating grounding plate. Because of this unique method of grounding, conduit entry may be made from the top, bottom or side. No other brand offers this type of installation versatility.

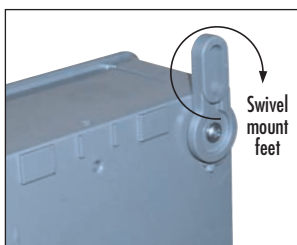

## A Pre-Molded Offset Dimple

Walther does not install a hub at the top of our mechanical interlocks, rather a pre-molded offset dimple (drill point) is provided instead of a conduit entry hole. This allows the installer to choose the size of the conduit to be used, and the location where the conduit will be attached to the enclosure (top, bottom or side entry) without the use of knockout plugs and reducers. Arranging the conduit entry hole at the dimple location will prevent condensation from falling directly on the interior electrical components, such as the switch. It will also allow for more room to pull conductors when wiring. Approximately 40% of all entry is from the bottom.

## Swivel Mount Feet (135°)

Swivel mount feet can be used for installations where irregular or tight fit applications exist.



## Compact Size

All versions and sizes are designed to fit within the web of an 8" column. This compact size allows the use of columns as a mounting location.

## Easy Identification

Catalog number, rating and certifications are indicated on the label for easy identification of mating devices.

## Color Coded Receptacle Covers

Receptacle covers are color-coded by voltage in accordance with IEC 309 standard.



## Completely Compatible

Completely compatible with not only Walther IEC 309-1 and 309-2 plugs, but with any manufacturer's plugs that conform to the IEC 309 standards and color coding system...anywhere in the world. When Walther IP67 plugs are used in-conjunction with NEMA 4X rated Walther mechanical interlocks, both devices are NEMA 4X rated.

## Micro Switch

Available upon request. May be used to transmit signal when plug is inserted or when switch is turned to the "ON" position. May also be used for indicator light to display and confirm when switch is turned "ON" or "OFF". Consult technical service for price and delivery.

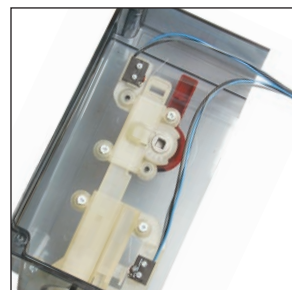



20, 30, 60 Amp  
**NEMA 4X Watertight (IP67)**  
 Drawing A  
 (See Drawing on Page 55)



20, 30, 60 Amp  
 Splashproof (IP44)  
 Drawing A  
 (See Drawing on Page 55)

Amps	Poles and Wires	Voltage AC	Clock Position of Ground Contact	Horsepower Ratings	NEMA 4X Watertight (IP67)	Splashproof (IP44)	
20	2P3W	120	4	0.75	AE119316	AE110316	
		240	6	2	AE119318	AE110318	
		480	7	4	AE119319	AE110319	
	3P4W	120/240	12	.75 @ 120V 2 @ 240V	AE119424	AE110424	
		3Ø240	9	5	AE119421	AE110421	
		3Ø480	7	10	AE119419	AE110419	
		3Ø600	5	14	AE119417	AE110417	
		3ØY120/208	9	5	AE119521	AE110521	
		3ØY277/480	7	10	AE119519	AE110519	
	4P5W	3ØY347/600	5	14	AE119517	AE110517	
2P3W		120	4	1.5	AE139316	AE130316	
		240	6	3.5	AE139318	AE130318	
	480	7	6	AE139319	AE130319		
30	3P4W	120/240	12	1.5 @ 120 3.5 @ 240	AE139424	AE130424	
		3Ø240	9	7.5	AE139421	AE130421	
		3Ø480	7	15	AE139419	AE130419	
	3Ø600	5	20	AE139417	AE130417		
	4P5W	3ØY120/208	9	7.5	AE139521	AE130521	
		3ØY277/480	7	15	AE139519	AE130519	
3ØY347/600		5	20	AE139517	AE130517		
32*	3P4W	380 50Hz 440 60Hz	3	12	AE139415		
60	2P3W	120	4	3.5	AE169316	AE160316	
		240	6	7.5	AE169318	AE160318	
		480	7	13.5	AE169319	AE160319	
	3P4W	120/240	12	3.5 @ 120 7.5 @ 240	AE169424	AE160424	
		3Ø240	9	15	AE169421	AE160421	
		3Ø480	7	28	AE169419	AE160419	
		3Ø600	5	35	AE169417	AE160417	
		4P5W	3ØY120/208	9	15	AE169521	AE160521
			3ØY277/480	7	28	AE169519	AE160419
	3ØY347/600		5	35	AE169517	AE160517	

\* 32 Amp. Only for Refrigerated Containers.



100 Amp  
**NEMA 4X Watertight (IP67)**  
 Drawing B  
 (See Drawing on Page 55)

100	2P3W	120	4	7.5	A0189316		
		240	6	14	A0189318		
		480	7	28	A0189319		
	3P4W	120/240	12	7.5 @ 120 14 @ 240	A0189424		
		3Ø240	9	30	A0189421		
		3Ø480	7	60	A0189419		
		3Ø600	5	75	A0189417		
		4P5W	3ØY120/208	9	30	A0189521	
			3ØY277/480	7	60	A0189519	
	3ØY347/600		5	75	A0189517		

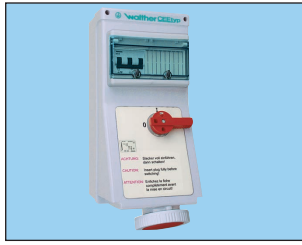

20, 30, 60 Amp  
NEMA 4X Watertight (IP67)  
Drawing C



20, 30, 60 Amp  
Splashproof (IP44)  
Drawing C

Amps	Poles and Wires	MCB	Voltage AC	Clock Position of Ground Contact	Horsepower Ratings	NEMA 4X Watertight (IP67)	Splashproof (IP44)
20	2P3W	1 Pole "C"	120	4	0.75	AL119316UD	AL110316UD
			240	6	2	AL119318UD	AL110318UD
			480	7	4	AL119319UD	AL110319UD
	3P4W	3 Pole "C"	120/240	12	.75 @ 120V 2 @ 240V	AL119424SA	AL110424SA
			3Ø240	9	5	AL119421SA	AL110421SA
			3Ø480	7	10	AL119419SA	AL110419SA
			3Ø600	5	14	AL119417SA	AL110417SA
	4P5W	3 Pole "C"	3ØY120/208	9	5	AL119521TA	AL110521TA
			3ØY277/480	7	10	AL119519TA	AL110519TA
3ØY347/600			5	14	AL119517TA	AL110517TA	
30	2P3W	1 Pole "C"	120	4	1.5	AL139316UD	AL130316UD
			240	6	3.5	AL139318UD	AL130318UD
			480	7	6	AL139319UD	AL130319UD
	3P4W	3 Pole "C"	120/240	12	1.5 @ 120 3.5 @ 240	AL139424SA	AL130424SA
			3Ø240	9	7.5	AL139421SA	AL130421SA
			3Ø480	7	15	AL139419SA	AL130419SA
			3Ø600	5	20	AL139417SA	AL130417SA
	4P5W	3 Pole "C"	3ØY120/208	9	7.5	AL139521TA	AL130521TA
			3ØY277/480	7	15	AL139519TA	AL130519TA
3ØY347/600			5	20	AL139517TA	AL130517TA	
32*	3P4W	3 Pole "C"	380 50Hz 440 60Hz	3	12	AL139415SA	
60	2P3W	1 Pole "C"	120	4	3.5	AL169316UD	AL160316UD
			240	6	7.5	AL169318UD	AL160318UD
			480	7	13.5	AL169319UD	AL160319UD
	3P4W	3 Pole "C"	120/240	12	3.5 @ 120 7.5 @ 240	AL169424SA	AL160424SA
			3Ø240	9	15	AL169421SA	AL160421SA
			3Ø480	7	28	AL169419SA	AL160419SA
			3Ø600	5	35	AL169417SA	AL160417SA
	4P5W	3 Pole "C"	3ØY120/208	9	15	AL169521TA	AL160521TA
			3ØY277/480	7	28	AL169519TA	AL160419TA
3ØY347/600			5	35	AL169517TA	AL160517TA	

\* 32 Amp. Only for Refrigerated Containers.

Dimensions

Amps	Poles and Wires	Unit of Measure	Dimensions														
			a	b	b1	c	d	e	IP44 f	NEMA 4X IP67 f	l	l1	IP44 n	NEMA 4X IP67 n	r		
20	16	2P3W	inch	12.44	5.94	4.49	0.26	14.57	7.20	7.17	7.60	6.50	7.20	15.79	15.91	8.11	
			mm	316	151	114	6.5	370	183	182	193	165	183	401	404	206	
20	16	3P4W	inch	12.44	5.94	4.49	0.26	14.57	7.20	7.36	7.64	6.50	7.20	15.91	15.94	8.11	
			mm	316	151	114	6.5	370	183	187	194	165	183	404	405	206	
20	16	4P5W	inch	12.44	5.94	4.49	0.26	14.57	7.20	7.24	7.72	6.50	7.20	15.94	16.14	8.11	
			mm	316	151	114	6.5	370	183	184	196	165	183	405	410	206	
30	32	2P3W	inch	12.44	5.94	4.49	0.26	14.57	7.20	7.36	7.91	6.50	7.20	16.34	16.46	8.11	
			mm	316	151	114	6.5	370	183	187	201	165	183	415	418	206	
30	32	3P4W	inch	12.44	5.94	4.49	0.26	14.57	7.20	7.36	7.91	6.50	7.20	16.34	16.46	8.11	
			mm	316	151	114	6.5	370	183	187	201	165	183	415	418	206	
30	32	4P5W	inch	12.44	5.94	4.49	0.26	14.57	7.20	7.44	7.91	6.50	7.20	16.42	16.46	8.11	
			mm	316	151	114	6.5	370	183	189	201	165	183	417	418	206	
60	63	2P3W	inch	12.44	5.94	4.49	0.26	14.57	7.20	7.72	8.23	6.50	7.20	17.01	17.44	8.11	
			mm	316	151	114	6.5	370	183	196	209	165	183	432	443	206	
60	63	3P4W	inch	12.44	5.94	4.49	0.26	14.57	7.20	7.72	8.23	6.50	7.20	17.01	17.44	8.11	
			mm	316	151	114	6.5	370	183	196	209	165	183	432	443	206	
60	63	4P5W	inch	12.44	5.94	4.49	0.26	14.57	7.20	7.72	8.23	6.50	7.20	17.01	17.44	8.11	
			mm	316	151	114	6.5	370	183	196	209	165	183	432	443	206	

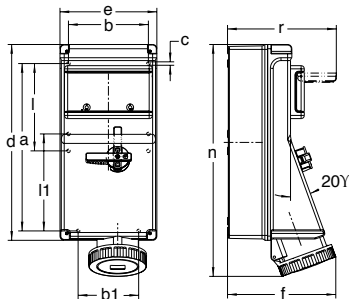

Drawing C



20, 30 Amp  
NEMA 4X Watertight (IP67)  
Drawing D



20, 30 Amp  
Splashproof (IP44)  
Drawing D

Amps	Poles and Wires	Voltage AC	Clock Position of Ground Contact	Horsepower Ratings	NEMA 4X Watertight (IP67)	Splashproof (IP44)	
20	2P3W	120	4	0.75	AT119316	AT110316	
		240	6	2	AT119318	AT110318	
		480	7	4	AT119319	AT110319	
	3P4W	120/240	12	.75 @ 120V 2 @ 240V	AT119424	AT110424	
		3Ø240	9	5	AT119421	AT110421	
		3Ø480	7	10	AT119419	AT110419	
		3Ø600	5	14	AT119417	AT110417	
		4P5W	3ØY120/208	9	5	AT119521	AT110521
			3ØY277/480	7	10	AT119519	AT110519
3ØY347/600	5		14	AT119517	AT110517		
30	2P3W	120	4	1.5	AT139316	AT130316	
		240	6	3.5	AT139318	AT130318	
		480	7	6	AT139319	AT130319	
	3P4W	120/240	12	1.5 @ 120 3.5 @ 240	AT139424	AT130424	
		3Ø240	9	7.5	AT139421	AT130421	
		3Ø480	7	15	AT139419	AT130419	
		3Ø600	5	20	AT139417	AT130417	
		4P5W	3ØY120/208	9	7.5	AT139521	AT130521
			3ØY277/480	7	15	AT139519	AT130519
	3ØY347/600		5	20	AT139517	AT130517	
	32*	3P4W	380 50Hz 440 60Hz	3	12	AT139415	

\* 32 Amp. Only for Refrigerated Containers.

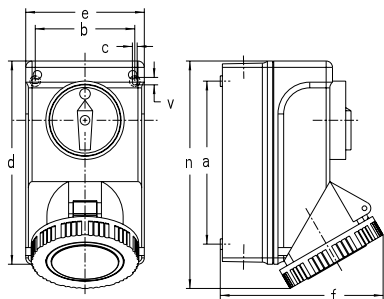

Drawing D

Dimensions

Amps		Poles and Wires	Unit of Measure	Dimensions							IP44		NEMA 4X IP67		NEMA 4X IP67	
N.A.	Int'l			a	b	c	d	e	f	f	n	n	v			
20	16	2P3W	inch	5.00	3.07	0.18	6.54	3.82	4.57	4.72	7.28	7.28	0.28			
			mm	127	78	4.5	166	97	116	120	185	185	7			
20	16	3P4W	inch	5.00	3.07	0.18	6.54	3.82	4.72	4.92	7.28	7.28	0.28			
			mm	127	78	4.5	166	97	120	125	185	185	7			
20	16	4P5W	inch	5.00	3.07	0.18	6.54	3.82	4.92	5.20	7.28	7.28	0.28			
			mm	127	78	4.5	166	97	125	132	185	185	7			
30	32	2P3W	inch	6.06	3.70	0.18	7.60	4.45	5.71	6.06	8.46	8.46	0.28			
			mm	154	94	4.5	193	113	145	154	215	215	7			
30	32	3P4W	inch	6.06	3.70	0.18	7.60	4.45	5.71	6.06	8.46	8.46	0.28			
			mm	154	94	4.5	193	113	145	154	215	215	7			
30	32	4P5W	inch	6.06	3.70	0.18	7.60	4.45	5.83	6.06	8.46	8.46	0.28			
			mm	154	94	4.5	193	113	148	154	215	215	7			



20, 30 Amp  
NEMA 4X Watertight (IP67)  
Drawing E



20, 30 Amp  
Splashproof (IP44)  
Drawing E

Amps	Poles and Wires	MCB	Voltage AC	Clock Position of Ground Contact	Horsepower Ratings	NEMA 4X Watertight (IP67)	Splashproof (IP44)
20	2P3W	1 Pole "C"	120	4	0.75	AU119316UD	AU110316UD
			240	6	2	AU119318UD	AU110318UD
			480	7	6	AU119319UD	AU110319UD
	3P4W	3 Pole "C"	120/240	12	.75 @ 120V 2 @ 240V	AU119424SA	AU110424SA
			3Ø240	9	5	AU119421SA	AU110421SA
			3Ø480	7	10	AU119419SA	AU810419SA
			3Ø600	5	14	AU119417SA	AU110417SA
	4P5W	3 Pole "C"	3ØY120/208	9	5	AU119521TA	AU110521TA
			3ØY277/480	7	10	AU119519TA	AU110519TA
3ØY347/600			5	14	AU119517TA	AU110517TA	
30	2P3W	1 Pole "C"	120	4	1.5	AU139316UD	AU130316UD
			240	6	3.5	AU139318UD	AU130318UD
			480	7	6	AU139319UD	AU130319UD
	3P4W	3 Pole "C"	120/240	12	1.5 @ 120 3.5 @ 240	AU139424SA	AU130424SA
			3Ø240	9	7.5	AU139421SA	AU130421SA
			3Ø480	7	15	AU139419SA	AU130419SA
			3Ø600	5	20	AU139417SA	AU130417SA
	4P5W	3 Pole "C"	3ØY120/208	9	7.5	AU139521TA	AU130521TA
			3ØY277/480	7	15	AU139519TA	AU130519TA
3ØY347/600			5	20	AU139517TA	AU130517TA	
32*	3P4W	3 Pole "C"	380 50Hz 440 60Hz	3	12	AU139415SA	

\* 32 Amp. Only for Refrigerated Containers.

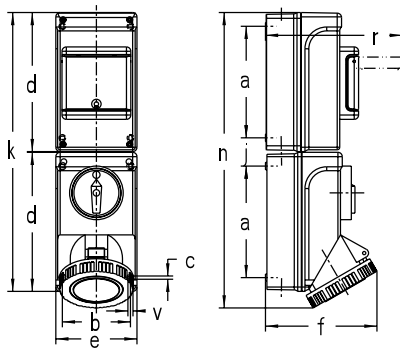

Drawing E

Dimensions

Amps	N.A.	Int'l	Poles and Wires	Unit of Measure	Dimensions													
					a	b	c	d	e	f	IP44 f	NEMA 4X IP67 f	i	k	IP44 n	NEMA 4X IP67 n	r	v
20	16	2P3W	inch	5.00	3.07	0.18	6.54	3.82	4.57	4.72	1.54	13.11	13.86	13.86	6.97	0.28		
				mm	127	78	4.5	166	97	116	120	39	333	352	352	177	7	
20	16	3P4W	inch	5.00	3.07	0.18	6.54	3.82	4.72	4.92	1.54	13.11	13.86	13.86	6.97	0.28		
				mm	127	78	4.5	166	97	120	125	39	333	352	352	177	7	
20	16	4P5W	inch	5.00	3.07	0.18	6.54	3.82	4.92	5.20	1.54	13.11	13.86	13.86	6.97	0.28		
				mm	127	78	4.5	166	97	125	132	39	333	352	352	177	7	
30	32	2P3W	inch	6.06	3.70	0.18	7.60	4.45	5.71	6.06	1.54	15.24	16.10	16.10	7.52	0.28		
				mm	154	94	4.5	193	113	145	154	39	387	409	409	191	7	
30	32	3P4W	inch	6.06	3.70	0.18	7.60	4.45	5.71	6.06	1.54	15.24	16.10	16.10	7.52	0.28		
				mm	154	94	4.5	193	113	145	154	39	387	409	409	191	7	
30	32	4P5W	inch	6.06	3.70	0.18	7.60	4.45	5.83	6.06	1.54	15.24	16.10	16.10	7.52	0.28		
				mm	154	94	4.5	193	113	148	154	39	387	409	409	191	7	



20, 30, 60, 100 Amp  
**NEMA 4X Watertight (IP67)**  
 Drawing B  
 (See Drawing on Page 55)



20, 30, 60 Amp  
 Splashproof (IP44)  
 Drawing A  
 (See Drawing on Page 55)

Amps	Poles and Wires	Voltage AC	Clock Position of Ground Contact	NEMA 4X Watertight (IP67)	Splashproof (IP44)
20	2P3W	120	4	AJ119316SH	AJ110316SH
		240	6	AJ119318SH	AJ110318SH
		480	7	AJ119319SH	AJ110319SH
	3P4W	120/240	12	AJ119424SH	AJ110424SH
		3Ø240	9	AJ119421SH	AJ110421SH
		3Ø480	7	AJ119419SH	AJ110419SH
	4P5W	3ØY120/208	9	AJ119521SH	AJ110521SH
		3ØY277/480	7	AJ119519SH	AJ110519SH
	30	2P3W	120	4	AJ139316SH
240			6	AJ139318SH	AJ130318SH
480			7	AJ139319SH	AJ130319SH
3P4W		120/240	12	AJ139424SH	AJ130424SH
		3Ø240	9	AJ139421SH	AJ130421SH
		3Ø480	7	AJ139419SH	AJ130419SH
4P5W		3ØY120/208	9	AJ139521SH	AJ130521SH
		3ØY277/480	7	AJ139519SH	AJ130519SH
32*		3P4W	380 50Hz 440 60Hz	3	AJ139415SH
60	2P3W	120	4	AJ169316SH	AJ160316SH
		240	6	AJ169318SH	AJ160318SH
		480	7	AJ169319SH	AJ160319SH
	3P4W	120/240	12	AJ169424SH	AJ160424SH
		3Ø240	9	AJ169421SH	AJ160421SH
		3Ø480	7	AJ169419SH	AJ160419SH
	4P5W	3ØY120/208	9	AJ169521SH	AJ160521SH
		3ØY277/480	7	AJ169519SH	AJ160519SH
	100	2P3W	120	4	A0189316SH
240			6	A0189318SH	
480			7	A0189319SH	
3P4W		120/240	12	A0189424SH	
		3Ø240	9	A0189421SH	
		3Ø480	7	A0189419SH	
4P5W		3ØY120/208	9	A0189521SH	
		3ØY277/480	7	A0189519SH	

\* 32 Amp. Only for Refrigerated Containers.



IEC 309  
 CIRCUIT BREAKER VERSION

**ELECTRICAL**

<b>Dielectric Voltage Withstand</b>	3,000 Volts
<b>Maximum Working Voltage</b>	600 Volts RMS (switch version) 480 Volts RMS (circuit breaker version)
<b>Current Interrupting</b>	Certified for current interrupting at full rated current and voltage.
<b>Short Circuit Withstand Rating</b>	Suitable for use on a circuit capable of delivering not more than 10,000 RMS symmetrical amperes at the voltage rating of the receptacle.
<b>Operations</b>	Mechanical: 10,000 cycles Electrical: 6,000 cycles

**MECHANICAL**

<b>Impact Resistance</b>	In accordance with UL 746C
<b>Terminal Identification</b>	In accordance with UL, CSA and international conventions.
<b>Product Identification</b>	Identification, ratings and color code in accordance with UL, CSA and IEC requirements.
<b>Lockout/Tagout</b>	"ON" and "OFF" lockout/tagout capability at switch handle. Complies with OSHA Reg. 29CFR 1910.147
<b>Mounting</b>	
Switch Version	Internal or external adjustable mounting feet
Compact Version	Internal mounting
Circuit Breaker Version	Internal or external adjustable mounting feet

**Minimum test requirements**

**ENVIRONMENTAL**

<b>Moisture Resistance</b>	Watertight IP67 (Washdown) - UL Type 4X Splashproof IP44
<b>Flammability</b>	UL94-5VA & V0 Classifications
<b>Operating Temperatures</b>	Maximum Continuous: 60°C (140°F) Minimum Continuous: -40°C (-40°F)
<b>UV Resistance</b>	UV stabilized material
<b>Chemicals</b>	Resists most standard industrial hydrocarbons, acids, bases and solvents.

**MATERIALS**

<b>Enclosure (all exterior components)</b>	UL94-5VA/V0, UV stabilized, impact modified Valox®.
<b>Contact Carrier</b>	Molded arc resistant UL94-V0 thermoplastic
<b>Gaskets</b>	Neoprene or EPDM
<b>Contacts (NEMA 4X, Watertight IP67)</b>	Brass, Nickel Plated
<b>Contacts (Splashproof IP44)</b>	Brass
<b>Hardware (screws &amp; springs)</b>	Steel with zinc-plated blue chromate or nickel plating.

**APPROVALS & COMPLIANCES**

- UL 508 (switch version) Motor Disconnect
- UL 508 (compact version) Manual Motor Controller
- UL 231 & UL 489 (circuit breaker version)
- UL1682 & 1686
- CSA C22.2 No. 14, 182.1
- IEC 309-1 & IEC 309-2

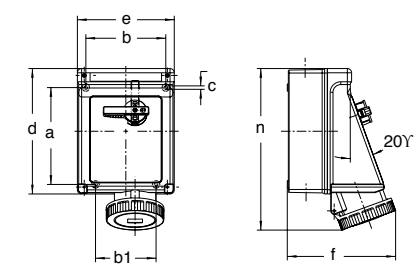

**Drawing A**

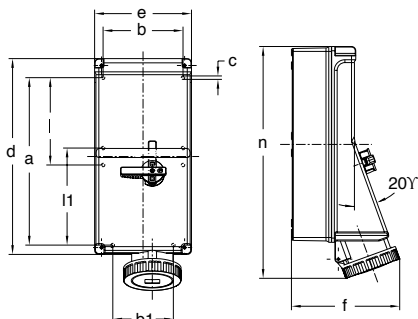

**Drawing B**

**Drawing A**

Amps		Poles and Wires	Unit of Measure	Dimensions										
N.A.	Int'l			a	b	b1	c	d	e	f	f	n	n	
20	16	2P3W	inch	7.20	5.94	4.49	0.26	9.33	7.20	7.17	7.60	10.55	10.63	
			mm	183	151	114	6.5	237	183	182	193	268	270	
20	16	3P4W	inch	7.20	5.94	4.49	0.26	9.33	7.20	7.36	7.64	10.63	10.71	
			mm	183	151	114	6.5	237	183	187	194	270	272	
20	16	4P5W	inch	7.20	5.94	4.49	0.26	9.33	7.20	7.24	7.72	10.75	10.91	
			mm	183	151	114	6.5	237	183	184	196	273	277	
30	32	2P3W	inch	7.20	5.94	4.49	0.26	9.33	7.20	7.36	7.91	11.10	11.22	
			mm	183	151	114	6.5	237	183	187	201	282	285	
30	32	3P4W	inch	7.20	5.94	4.49	0.26	9.33	7.20	7.36	7.91	11.10	11.22	
			mm	183	151	114	6.5	237	183	189	201	284	289	
30	32	4P5W	inch	7.20	5.94	4.49	0.26	9.33	7.20	7.44	7.91	11.18	11.38	
			mm	183	151	114	6.5	237	183	189	201	284	289	
60	63	2P3W	inch	7.20	5.94	4.49	0.26	9.33	7.20	7.72	8.23	11.89	12.17	
			mm	183	151	114	6.5	237	183	196	209	302	309	
60	63	3P4W	inch	7.20	5.94	4.49	0.26	9.33	7.20	7.72	8.23	11.89	12.17	
			mm	183	151	114	6.5	237	183	196	209	302	309	
60	63	4P5W	inch	7.20	5.94	4.49	0.26	9.33	7.20	7.72	8.23	11.89	12.17	
			mm	183	151	114	6.5	237	183	196	209	302	309	

**Drawing B**

Amps		Poles and Wires	Unit of Measure	Dimensions										
N.A.	Int'l			a	b	b1	c	d	e	f	f	n	n	
100	125	2P3W	inch	12.44	5.94	4.96	0.26	14.57	7.20	9.57	17.72			
			mm	316	151	126	6.5	370	183	243	450			
100	125	3P4W	inch	12.44	5.94	4.96	0.26	14.57	7.20	9.57	17.72			
			mm	316	151	126	6.5	370	183	243	450			
100	125	4P5W	inch	12.44	5.94	4.96	0.26	14.57	7.20	9.57	17.72			
			mm	316	151	126	6.5	370	183	243	450			



16, 32, 63 Amp  
Watertight (IP67)  
Drawing A  
(See Drawing on Page 55)



16, 32, 63 Amp  
Splashproof (IP44)  
Drawing A  
(See Drawing on Page 55)

Amps	Poles and Wires	Voltage AC	Clock Position of Ground Contact	NEMA 4X Watertight (IP67)	Splashproof (IP44)	
16	2P3W	110	4	AE119304	AE110304	
		230	6	AE119306	AE110306	
		400	9	AE119309	AE110309	
	3P4W	110	4	AE119404	AE110404	
		230	9	AE119409	AE110409	
		400	6	AE119406	AE110406	
		500	7	AE119407	AE110407	
	4P5W	110	4	AE119504	AE110504	
		230	9	AE119509	AE110509	
		400	6	AE119	AE110	
	32	2P3W	110	4	AE139304	AE130304
			230	6	AE139306	AE130306
400			9	AE139309	AE130309	
3P4W		110	4	AE139404	AE130404	
		230	9	AE139409	AE130409	
		400	6	AE139406	AE130406	
		500	7	AE139407	AE130407	
4P5W		110	4	AE139504	AE130504	
		230	9	AE139509	AE130509	
		400	6	AE139	AE130	
32*		3P4W	380 50Hz 440 60Hz	3	AE139403	
63		2P3W	110	4	AE169304	AE160304
	230		6	AE169306	AE160306	
	400		9	AE169309	AE160309	
	3P4W	110	4	AE169404	AE160404	
		230	9	AE169409	AE160409	
		400	6	AE169406	AE160406	
		500	7	AE169407	AE160407	
	4P5W	110	4	AE169504	AE160504	
		230	9	AE169509	AE160509	
		400	6	AE169	AE160	

\* 32 Amp. Only for Refrigerated Containers.



125 Amp  
Watertight (IP67)  
Drawing B  
(See Drawing on Page 55)

125	2P3W	110	4	A0179304	
		230	6	A0179306	
		400	9	A0179309	
	3P4W	110	4	A0179404	
		230	9	A0179409	
		400	6	A0179406	
		500	7	A0179407	
	4P5W	110	4	A0179504	
		230	9	A0179509	
		400	6	A0179	





16, 32, 63 Amp  
Watertight (IP67)  
Drawing C



16, 32, 63 Amp  
Splashproof (IP44)  
Drawing C

Amps	Poles and Wires	MCB	Voltage AC	Clock Position of Ground Contact	NEMA 4X Watertight (IP67)	Splashproof (IP44)	
16	2P3W	1 Pole "C"	110	4	AL119304UD	AL110304UD	
			230	6	AL119306UD	AL110306UD	
			400	9	AL119309UD	AL110309UD	
	3P4W	3 Pole "C"	110	4	AL119404SA	AL110404SA	
			230	9	AL119409SA	AL110409SA	
			400	6	AL119406SA	AL110406SA	
			500	7	AL119407SA	AL110407SA	
	4P5W	3 Pole "C"	110	4	AL119504TA	AL110504TA	
			230	9	AL119509TA	AL110509TA	
			400	6	AL119TA	AL110TA	
	32	2P3W	1 Pole "C"	110	4	AL139304UD	AL130304UD
				230	6	AL139306UD	AL130306UD
400				9	AL139309UD	AL130309UD	
3P4W		3 Pole "C"	110	4	AL139404SA	AL130404SA	
			230	9	AL139409SA	AL130409SA	
			400	6	AL139406SA	AL130406SA	
			500	7	AL139407SA	AL130407SA	
4P5W		3 Pole "C"	110	4	AL139504TA	AL130504TA	
			230	9	AL139509TA	AL130509TA	
			400	6	AL139TA	AL130TA	
32*		3P4W	3 Pole "C"	380 50Hz 440 60Hz	3	AL139403SA	
63		2P3W	1 Pole "C"	110	4	AL169304UD	AL160304UD
	230			6	AL169306UD	AL160306UD	
	400			9	AL169309UD	AL160309UD	
	3P4W	3 Pole "C"	110	4	AL169404SA	AL160404SA	
			230	9	AL169409SA	AL160409SA	
			400	6	AL169406SA	AL160406SA	
			500	7	AL169407SA	AL160407SA	
	4P5W	3 Pole "C"	110	4	AL169504TA	AL160504TA	
			230	9	AL169509TA	AL160509TA	
			400	6	AL169TA	AL160TA	

\* 32 Amp. Only for Refrigerated Containers.

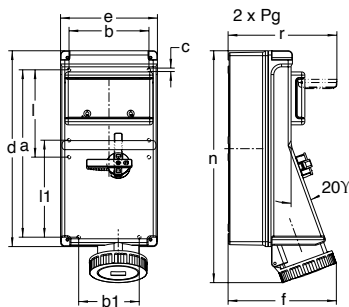

Drawing C

### Dimensions

Amps	N.A.	Int'l	Poles and Wires	Unit of Measure	Dimensions															
					a	b	b1	c	d	e	f	IP44	NEMA 4X IP67	f	l	l1	IP44	NEMA 4X IP67	n	r
20	16	2P3W	inch	12.44	5.94	4.49	0.26	14.57	7.20	7.17	7.60	6.50	7.20	15.79	15.91	8.11				
			mm	316	151	114	6.5	370	183	182	193	165	183	401	404	206				
20	16	3P4W	inch	12.44	5.94	4.49	0.26	14.57	7.20	7.36	7.64	6.50	7.20	15.91	15.94	8.11				
			mm	316	151	114	6.5	370	183	187	194	165	183	404	405	206				
20	16	4P5W	inch	12.44	5.94	4.49	0.26	14.57	7.20	7.24	7.72	6.50	7.20	15.94	16.14	8.11				
			mm	316	151	114	6.5	370	183	184	196	165	183	405	410	206				
30	32	2P3W	inch	12.44	5.94	4.49	0.26	14.57	7.20	7.36	7.91	6.50	7.20	16.34	16.46	8.11				
			mm	316	151	114	6.5	370	183	187	201	165	183	415	418	206				
30	32	3P4W	inch	12.44	5.94	4.49	0.26	14.57	7.20	7.36	7.91	6.50	7.20	16.34	16.46	8.11				
			mm	316	151	114	6.5	370	183	187	201	165	183	415	418	206				
30	32	4P5W	inch	12.44	5.94	4.49	0.26	14.57	7.20	7.44	7.91	6.50	7.20	16.42	16.46	8.11				
			mm	316	151	114	6.5	370	183	189	201	165	183	417	418	206				
60	63	2P3W	inch	12.44	5.94	4.49	0.26	14.57	7.20	7.72	8.23	6.50	7.20	17.01	17.44	8.11				
			mm	316	151	114	6.5	370	183	196	209	165	183	432	443	206				
60	63	3P4W	inch	12.44	5.94	4.49	0.26	14.57	7.20	7.72	8.23	6.50	7.20	17.01	17.44	8.11				
			mm	316	151	114	6.5	370	183	196	209	165	183	432	443	206				
60	63	4P5W	inch	12.44	5.94	4.49	0.26	14.57	7.20	7.72	8.23	6.50	7.20	17.01	17.44	8.11				
			mm	316	151	114	6.5	370	183	196	209	165	183	432	443	206				



16, 32 Amp  
Watertight (IP67)  
Drawing D



16, 32 Amp  
Splashproof (IP44)  
Drawing D

Amps	Poles and Wires	Voltage AC	Position of Ground Contact	NEMA 4X Watertight (IP67)	Clock Splashproof (IP44)	
16	2P3W	110	4	AT119304	AT110304	
		230	6	AT119306	AT110306	
		400	9	AT119309	AT110309	
	3P4W	110	4	AT119404	AT110404	
		230	9	AT119409	AT110409	
		400	6	AT119406	AT110406	
		500	7	AT119407	AT110407	
		400	6	AT119	AT110	
	4P5W	110	4	AT119504	AT110504	
		230	9	AT119509	AT110509	
		400	6	AT119	AT110	
	32	2P3W	110	4	AT139304	AT130304
230			6	AT139306	AT130306	
400			9	AT139309	AT130309	
3P4W		110	4	AT139404	AT130404	
		230	9	AT139409	AT130409	
		400	6	AT139406	AT130406	
		500	7	AT139407	AT130407	
4P5W		110	4	AT139504	AT130504	
		230	9	AT139509	AT130509	
		400	6	AT139	AT130	
32*		3P4W	380 50Hz 440 60Hz	3	AT139403	

\* 32 Amp. Only for Refrigerated Containers.

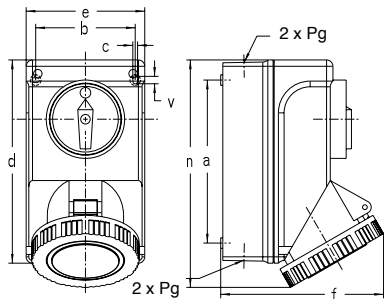

Drawing D

Dimensions

Amps	Poles and Wires	Unit of Measure	Dimensions										
			N.A.	Int'l	a	b	c	d	e	IP44 f	NEMA 4X IP67 f	IP44 n	NEMA 4X IP67 n
20	16	2P3W	inch	5.00	3.07	0.18	6.54	3.82	4.57	4.72	7.28	7.28	0.28
			mm	127	78	4.5	166	97	116	120	185	185	7
20	16	3P4W	inch	5.00	3.07	0.18	6.54	3.82	4.72	4.92	7.28	7.28	0.28
			mm	127	78	4.5	166	97	120	125	185	185	7
20	16	4P5W	inch	5.00	3.07	0.18	6.54	3.82	4.92	5.20	7.28	7.28	0.28
			mm	127	78	4.5	166	97	125	132	185	185	7
30	32	2P3W	inch	6.06	3.70	0.18	7.60	4.45	5.71	6.06	8.46	8.46	0.28
			mm	154	94	4.5	193	113	145	154	215	215	7
30	32	3P4W	inch	6.06	3.70	0.18	7.60	4.45	5.71	6.06	8.46	8.46	0.28
			mm	154	94	4.5	193	113	145	154	215	215	7
30	32	4P5W	inch	6.06	3.70	0.18	7.60	4.45	5.83	6.06	8.46	8.46	0.28
			mm	154	94	4.5	193	113	148	154	215	215	7



16, 32 Amp  
Watertight (IP67)  
Drawing E



16, 32 Amp  
Splashproof (IP44)  
Drawing E

Amps	Poles and Wires	MCB	Voltage AC	Clock Position of Ground Contact	NEMA 4X Watertight (IP67)	Splashproof (IP44)	
16	2P3W	1 Pole "C"	110	4	AU119304UD	AU110304UD	
			230	6	AU119306UD	AU110306UD	
			400	9	AU119309UD	AU110309UD	
	3P4W	3 Pole "C"	110	4	AU119404SA	AU110404SA	
			230	6	AU119406SA	AU110406SA	
			400	9	AU119409SA	AU810409SA	
			500	7	AU119407SA	AU110407SA	
	4P5W	3 Pole "C"	110	4	AU119504TA	AU110504TA	
			230	9	AU119509TA	AU110509TA	
			400	6	AU119TA	AU110TA	
	32	2P3W	1 Pole "C"	110	4	AU139304UD	AU130304UD
				230	6	AU139306UD	AU130306UD
400				9	AU139309UD	AU130309UD	
3P4W		3 Pole "C"	110	4	AU139404SA	AU130404SA	
			230	9	AU139409SA	AU130409SA	
			400	6	AU139406SA	AU130406SA	
			500	7	AU139407SA	AU130407SA	
4P5W		3 Pole "C"	110	4	AU139504TA	AU130504TA	
			230	9	AU139509TA	AU130509TA	
			400	6	AU139TA	AU130TA	
32*		3P4W	3 Pole "C"	380 50Hz 440 60Hz	3	AU139403SA	

\* 32 Amp. Only for Refrigerated Containers.

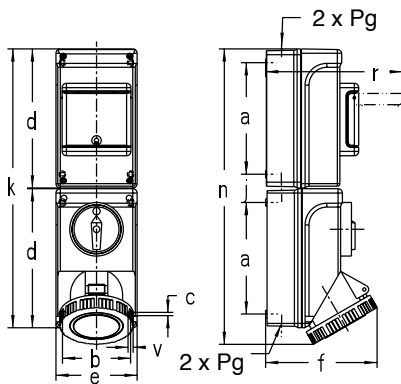

Drawing E

Amps		Poles and Wires	Unit of Measure	Dimensions												
N.A.	Int'l			a	b	c	d	e	f	IP44 f	NEMA 4X IP67 f	i	k	IP44 n	NEMA 4X IP67 n	r
20	16	2P3W	inch	5.00	3.07	0.18	6.54	3.82	4.57	4.72	1.54	13.11	13.86	13.86	6.97	0.28
			mm	127	78	4.5	166	97	116	120	39	333	352	352	177	7
20	16	3P4W	inch	5.00	3.07	0.18	6.54	3.82	4.72	4.92	1.54	13.11	13.86	13.86	6.97	0.28
			mm	127	78	4.5	166	97	120	125	39	333	352	352	177	7
20	16	4P5W	inch	5.00	3.07	0.18	6.54	3.82	4.92	5.20	1.54	13.11	13.86	13.86	6.97	0.28
			mm	127	78	4.5	166	97	125	132	39	333	352	352	177	7
30	32	2P3W	inch	6.06	3.70	0.18	7.60	4.45	5.71	6.06	1.54	15.24	16.10	16.10	7.52	0.28
			mm	154	94	4.5	193	113	145	154	39	387	409	409	191	7
30	32	3P4W	inch	6.06	3.70	0.18	7.60	4.45	5.71	6.06	1.54	15.24	16.10	16.10	7.52	0.28
			mm	154	94	4.5	193	113	145	154	39	387	409	409	191	7
30	32	4P5W	inch	6.06	3.70	0.18	7.60	4.45	5.83	6.06	1.54	15.24	16.10	16.10	7.52	0.28
			mm	154	94	4.5	193	113	148	154	39	387	409	409	191	7



16, 32, 63, 125 Amp  
Watertight (IP67)  
Drawing B  
(See Drawing on Page 49)



16, 32, 63, 125 Amp  
Splashproof (IP44)  
Drawing B  
(See Drawing on Page 49)

Amps	Poles and Wires	Voltage AC	Clock Position of Ground Contact	NEMA 4X Watertight (IP67)	Splashproof (IP44)
16	2P3W	110	4	AJ119304SH	AJ110304SH
		230	6	AJ119306SH	AJ110306SH
		400	9	AJ119309SH	AJ110309SH
	3P4W	110	4	AJ119404SH	AJ110404SH
		230	9	AJ119409SH	AJ110409SH
		400	6	AJ119406SH	AJ110406SH
	4P5W	110	4	AJ119504SH	AJ110504SH
		230	9	AJ119509SH	AJ110509SH
		400	6	AJ1195SH	AJ1105SH
32	2P3W	110	4	AJ139304SH	AJ130304SH
		230	6	AJ139306SH	AJ130306SH
		400	9	AJ139309SH	AJ130309SH
	3P4W	110	4	AJ139404SH	AJ130404SH
		230	9	AJ139409SH	AJ130409SH
		400	6	AJ139406SH	AJ130406SH
	4P5W	110	4	AJ139504SH	AJ130504SH
		230	9	AJ139509SH	AJ130509SH
		400	6	AJ1395SH	AJ1305SH
32*	3P4W	380 50Hz 440 60Hz	3	AJ139403SH	
63	2P3W	110	4	AJ169304SH	AJ160304SH
		230	6	AJ169306SH	AJ160306SH
		400	9	AJ169309SH	AJ160309SH
	3P4W	110	4	AJ169404SH	AJ160404SH
		230	9	AJ169409SH	AJ160409SH
		400	6	AJ169406SH	AJ160406SH
	4P5W	110	4	AJ169504SH	AJ160504SH
		230	9	AJ169509SH	AJ160509SH
		400	6	AJ1695SH	AJ1605SH
125	2P3W	110	4	AO179304SH	
		230	6	AO179306SH	
		400	9	AO179309SH	
	3P4W	110	4	AO179404SH	
		230	9	AO179409SH	
		400	6	AO179406SH	
	4P5W	110	4	AO179504SH	
		230	9	AO179509SH	
		400	6	AO1795SH	

\* 32 Amp. Only for Refrigerated Containers.

# MANUAL DISCONNECT SWITCH



## SAFETY

Walthers' Manual Disconnect Switch combines a horsepower rated switch in a tough, impervious NEMA 4X enclosure for safe motor load disconnect. The bright yellow and red padlock handle provides lockout protection, in the "OFF" position, to comply with OSHA Lockout/Tagout regulations. In addition, the enclosure cover cannot be removed from the body until the switch is turned to the "OFF" position.

The nonmetallic enclosure, while abuse and corrosion resistant, is also non-conductive, which enhances the safety of the product. The device can be connected to metallic conduit without interfering with the ground continuity.

## RELIABILITY

Walthers horsepower rated switches are available with ratings from 20 to 150amps. Type NEMA 4X enclosures are designed for the most demanding environments and provide excellent protection against corrosion, dirt, dust splashing water and hose directed water spray. Walthers Type 4X enclosures provide exceptional UV Stability, excellent insulating properties and are made of a material that is self-extinguishing. (Flame retarded UL94 V0)



The Buzzie™ Switch Guard. Protect your Walthers switches from possible damage from lift trucks and other workplace mishaps. (shown with KEM325UL-Y/R). Consult customer service for more information.

## NEC ARTICLE 430

Walthers' Disconnect Switch is designed to meet National Electric Code, Article 430-102, requiring a disconnecting means, located within sight, from the motor location and the driven machinery location.

## APPROVALS & COMPLIANCES

UL 508 Motor Disconnect



# MANUAL DISCONNECT SWITCH

## Enclosed Motor Disconnect Switch



### Catalog Number

Black Handle	KEM325UL	KEM340UL	KEM360UL	KEM380UL
Yellow/ Red Handle	KEM325UL Y/R	KEM340UL Y/R	KEM360UL Y/R	KEM380UL Y/R
No. of Poles	3*	3*	3*	3*
General Purpose Current	25A	40A	60A	80A
Maximum Voltage	600V AC	600V AC	600V AC	600V AC
Motor FLA @ 480V AC	17.5A	28A	34A	—
Motor FLA @ 600V AC	11A	18A	27A	47A

Horsepower Rating /HP	1 Phase	3 Phase	1 Phase	3 Phase	1 Phase	3 Phase	1 Phase	3 Phase
110-120V AC	1	2	2	3	3	5	3	7.5
200V AC	2	5	3	7.5	5	10	7.5	10
208V AC	2	5	3	7.5	5	10	7.5	15
220-240V AC	3	7.5	5	10	5	10	7.5	15
265V AC	3	7.5	5	10	5	10	10	20
277V AC	3	7.5	5	10	7.5	10	10	20
380-415V AC	5	10	7.5	15	10	20	15	25
440-480V AC	7.5	15	10	20	15	25	20	30
550-600V AC	5	10	7.5	15	15	25	25	40

Short Circuit Withstand Rating at 600 V with Max. Fuse Size/Class:	10kA	10kA	10kA	10kA
K5	50A	50A	60A	150A
RK5	50A	50A	60A (80A @ 480V AC)	150A
RK1	80A	80A	100A	—
J	80A	80A	100A	200A

<b>Terminal Size Acceptability</b> (Cu Conductors only, 75°C)	14-8AWG	14-8AWG	12-4AWG	4-1/0AWG
<b>Terminal Torque</b>	16 lb. in.	16 lb. in.	16 lb. in.	50 lb. in.
<b>Environmental Rating</b>	NEMA Type 4X	NEMA Type 4X	NEMA Type 4X	NEMA Type 4X
<b>Enclosure Type Used</b>	U2	U3	U3	U3

### Dimensions

(to convert to inches multiply by 0.03937)

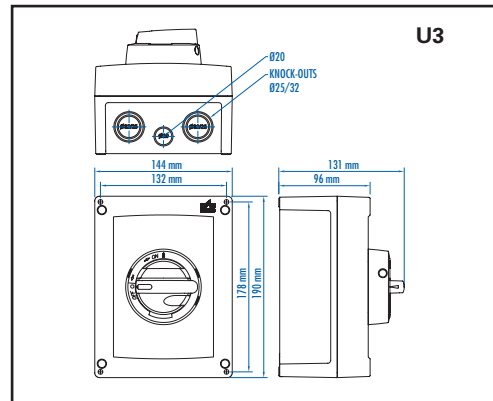
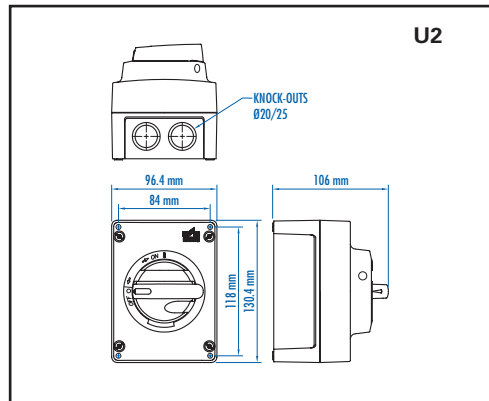

<b>Weight</b>	0.49kg (1 lb.-1.3 oz.)	0.72kg (1 lb.-9.6 oz.)	0.773kg (1 lb.-11.2 oz.)	1.021kg (2 lb.-4.0 oz.)
---------------	------------------------	------------------------	--------------------------	-------------------------

### Suitable Accessories

<b>Auxiliary Contacts</b>	KU1.V, KU2.V	KU1.V, KU2.V	KU1.V, KU2.V	VKA1.V, VKA2.V
---------------------------	--------------	--------------	--------------	----------------

\*Also available in 4 pole models.

# MANUAL DISCONNECT SWITCH

## Enclosed Motor Disconnect Switch

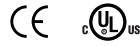

KEM3100L  
KEM3100L Y/R

3*
100A
600V AC
—
54A

1 Phase	3 Phase
3	7.5
7.5	15
7.5	15
10	20
10	20
10	20
15	30
20	40
30	50

10kA
150A
150A
—
200A

4-1/0AWG

50 lb. in.
NEMA Type 4X
MF10



KEM3125L  
KEM3125L Y/R

3*
125A
600V AC
—
68A

1 Phase	3 Phase
5	10
10	20
10	20
15	25
15	25
15	30
20	40
30	50
30	60

10kA
150A
150A
—
200A

4-1/0AWG

50 lb. in.
NEMA Type 4X
MF10



KEM3150L  
KEM3150L Y/R

3*
150A
600V AC
—
83A

1 Phase	3 Phase
7.5	10
10	25
10	25
15	30
15	30
20	30
25	50
30	60
40	75

10kA
150A
150A
—
200A

4-1/0AWG

50 lb. in.
NEMA Type 4X
MF11UL

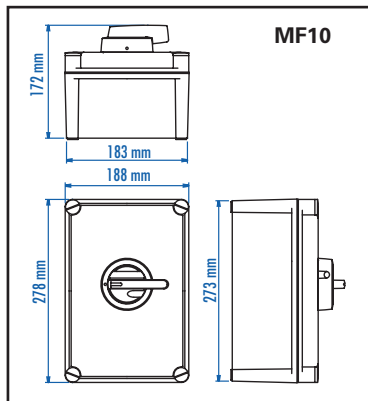

1.9051kg (4 lb. 3.2 oz.)

VKA1.V, VKA2.V

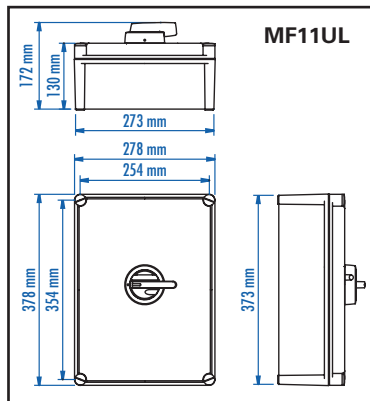

1.9051kg (4 lb. 3.2 oz.)

VKA1.V, VKA2.V

2.8351kg (6 lb. 4.0 oz.)

VKA1.V, VKA2.V

## FUSED



KKVM332, KKVM332CC  
KKVM332 Y/R, KKVM332CC Y/R

3
30A
600V AC

Cat. No.	Fuse Type
KKVM 332 (Y/R)	10x38, Midget
KKVM 332CC (Y/R)	Class CC

100kA
-------

14-8AWG

16 lb. in.
NEMA Type 4X
U3

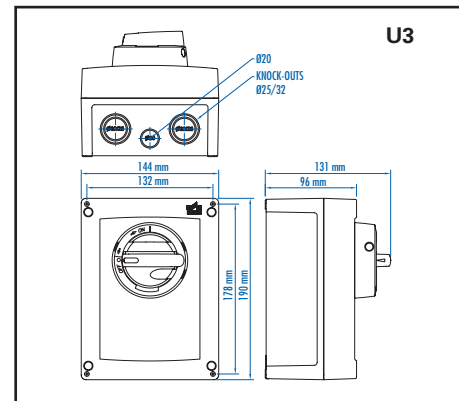

0.998kg (2 lb.-3.2oz.)

KU1.V, KU2.V

# MANUAL DISCONNECT SWITCH

## Extended/Direct Handle Motor Disconnect Switch

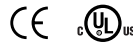

The KU/VKA...N series can be used with extended and direct handles (see page 8-9 for details).



Catalog Number	KU325N	KU340N	KU363N
No. of Poles	3 (4 pole - KU425N)	3 (4 pole - KU440N)	3 (4 pole - KU463N)
General Purpose Current	25A	40A	60A
Maximum Voltage	600V AC	600V AC	600V AC
Motor FLA @ 480V AC	17.5A	28A	34A
Motor FLA @ 600V AC	11A	18A	27A

Horsepower Rating /HP	3 Pole		3 Pole		3 Pole	
	1 Phase	3 Phase	1 Phase	3 Phase	1 Phase	3 Phase
110-120V AC	1	2	2	3	3	5
200V AC	2	5	3	7.5	5	10
208V AC	2	5	3	7.5	5	10
220-240V AC	3	7.5	5	10	5	10
265V AC	3	7.5	5	10	5	10
277V AC	3	7.5	5	10	7.5	10
380-415V AC	5	10	7.5	15	10	20
440-480V AC	7.5	15	10	20	15	25
550-600V AC	5	10	7.5	15	15	25

Short Circuit Withstand Rating at 600V with Max. Fuse Size/Class:	10kA	10kA	10kA
K5	50A	50A	60A
RK5	50A	50A	60A (80A@480V AC)
RK1	80A	80A	100A
J	80A	80A	100A

Terminal Size Acceptability (Cu Conductors only, 75°C)	14-8AWG	14-8AWG	12-4AWG
Terminal Torque	16 lb. in.	16 lb. in.	16 lb. in.

**Dimensions**  
(to convert to inches multiply by 0.03937)

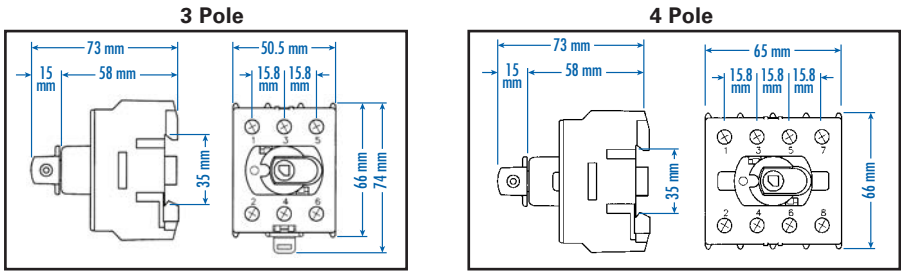

Weight	0.172Kg (0.379lb.) (3 pole) 0.215Kg (0.474lb.) (4 pole)	0.172Kg (0.379lb.) (3 pole) 0.215Kg (0.474lb.) (4 pole)	0.172Kg (0.379lb.) (3 pole) 0.215Kg (0.474lb.) (4 pole)
--------	------------------------------------------------------------	------------------------------------------------------------	------------------------------------------------------------

### Suitable Accessories

#### Extended Handle Version/ Door Interlock Mechanism

Shaft	L1(2,3)00AD11-ST	L1(2,3)00AD11-ST	L1(2,3)00AD11-ST
Handles	LK10 (Y/R) UL, LK11 (Y/R) U	LK10 (Y/R) UL, LK11 (Y/R) U	LK10 (Y/R) UL, LK11 (Y/R) U
Auxiliary Switch	KU1.V, KU2.V	KU1.V, KU2.V	KU1.V, KU2.V
Fuse Holder	-	KV 10x38, KV 10x38 CC	-

#### Direct Handle Version

Handle for 3 Pole	K/KU3P (Y/R)	K/KU3P (Y/R)	K/KU3P (Y/R)
Handle for 4 Pole	K/KU4P (Y/R)	K/KU4P (Y/R)	K/KU4P (Y/R)
Door Mounting Kits	OKA0.V (Y/R), OKA/KU LK10 ( Y/R)	OKA0.V (Y/R), OKA/KU LK10 ( Y/R)	OKA0.V (Y/R), OKA/KU LK10 ( Y/R)



# MANUAL DISCONNECT SWITCH

## Extended/Direct Handle Motor Disconnect Switch

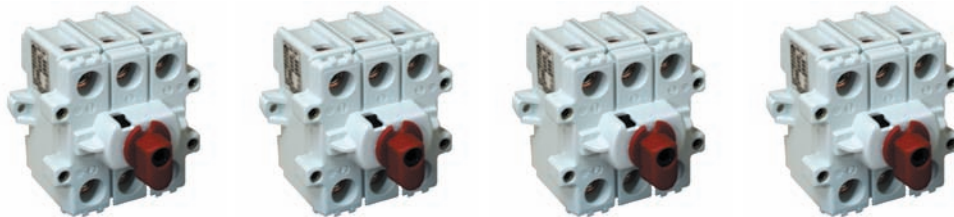

Catalog Number	VKA380N	VKA3100N	VKA3125N	VKA3160N
No. of Poles	3 (4 pole - VKA480N)	3 (4 pole - VKA4100N)	3 (4 pole - VKA4125N)	3 (4 pole - VKA4160N)
General Purpose Current	80A	100A	125A	150A
Maximum Voltage	600V AC	600V AC	600V AC	600V AC
Motor FLA @ 480V AC	—	—	—	—
Motor FLA @ 600V AC	47A	54A	68A	83A

Horsepower Rating /HP	1 Phase		3 Phase		1 Phase		3 Phase		1 Phase		3 Phase	
	3	7.5	3	7.5	5	10	7.5	10	7.5	10	7.5	10
110-120V AC	3	7.5	3	7.5	5	10	7.5	10	7.5	10	7.5	10
200V AC	7.5	10	7.5	15	10	20	10	20	10	25	10	25
208V AC	7.5	15	7.5	15	10	20	10	20	10	25	10	25
220-240V AC	7.5	15	10	20	15	25	15	25	15	30	15	30
265V AC	10	20	10	20	15	25	15	25	20	30	20	30
277V AC	10	20	10	20	15	30	20	30	20	30	20	30
380-415V AC	15	25	15	30	20	40	25	40	25	50	25	50
440-480V AC	20	30	20	40	25	50	30	50	30	60	30	60
550-600V AC	25	40	30	50	30	60	40	60	40	75	40	75

Short Circuit Withstand Rating at 600 V with Max. Fuse Size/Class:	10kA	10kA	10kA	10kA
K5	150A	150A	150A	150A
RK5	150A	150A	150A	150A
RK1	—	—	—	—
J	200A	200A	200A	200A

Terminal Size Acceptability (Cu Conductors only, 75°C)	4-1/0AWG	4-1/0AWG	4-1/0AWG	4-1/0AWG
Terminal Torque	50 lb. in.	50 lb. in.	50 lb. in.	50 lb. in.

**Dimensions**  
(to convert to inches multiply by 0.03937)

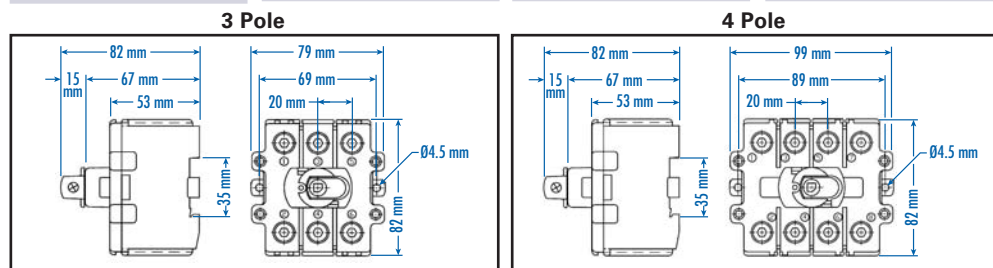

Weight	0.480Kg (1.058lb.) (3pole) 0.620Kg (1.367lb.) (4pole)	0.480Kg (1.058lb.) (3pole) 0.620Kg (1.367lb.) (4pole)	0.480Kg (1.058lb.) (3pole) 0.620Kg (1.367lb.) (4pole)	0.480Kg (1.058lb.) (3pole) 0.620Kg (1.367lb.) (4pole)
--------	----------------------------------------------------------	----------------------------------------------------------	----------------------------------------------------------	----------------------------------------------------------

### Suitable Accessories

#### Extended Handle Version/ Door Interlock Mechanism

Shaft	L1(2.3)00AD11-ST	L1(2.3)00AD11-ST	L1(2.3)00AD11-ST	L1(2.3)00AD11-ST
Handles	LK10 (Y/R) UL, LK11 (Y/R) U	LK10 (Y/R) UL, LK11 (Y/R) U	LK10 (Y/R) UL, LK11 (Y/R) U	LK10 (Y/R) UL, LK11 (Y/R) U
Auxiliary Switch	VKA1.V, VKA2.V	VKA1.V, VKA2.V	VKA1.V, VKA2.V	VKA1.V, VKA2.V
Fuse Holder	—	—	—	—

#### Direct Handle Version

Handle for 3 & 4 Pole	K/VKA3-4P (Y/R)	K/VKA3-4P (Y/R)	K/VKA3-4P (Y/R)	K/VKA3-4P (Y/R)
Door Mounting Kit	OKA/V LK11 (Y/R)	OKA/V LK11 (Y/R)	OKA/V LK11 (Y/R)	OKA/V LK11 (Y/R)

# MANUAL DISCONNECT SWITCH

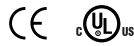

## Extended Handle Accessories

### DOOR INTERLOCK HANDLES

#### LK10 (Y/R) UL:

- Single hole mounting (22.5mm)
- Defeatable (built-in mechanism)



#### LK11 (Y/R) U:

- Retention mechanism (only rotates 90° from off to on, keeps handle in off position while cabinet door is open)
- Defeatable (looses NEMA rating)

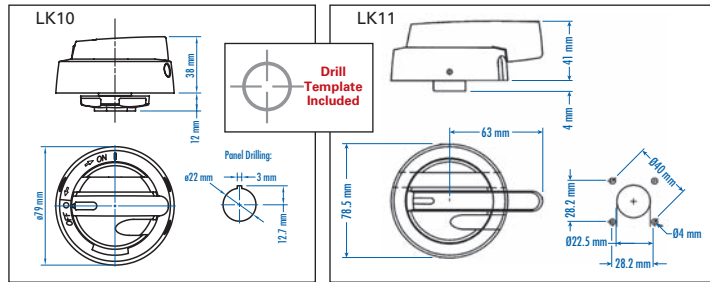

Cat. No.	LK10 UL	LK10 Y/R UL	LK11 U	LK11 Y/R U
<b>Environmental Rating</b>	NEMA Type 4X, IP66	NEMA Type 4X, IP66	NEMA Type 4X, IP67	NEMA Type 4X, IP67
<b>Color</b>	Black	Yellow/Red	Black	Yellow/Red

### DOOR INTERLOCK SHAFT

The steel shaft ensures reliable operation even in the toughest conditions.

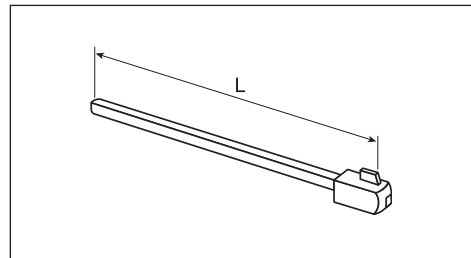

Cat. No.	L100AD11-ST	L200AD11-ST	L300AD11-ST
<b>Length (L)</b>	100mm	200mm	300mm
<b>Material</b>	Steel	Steel	Steel

### AUXILIARY SWITCHES

The auxiliary switches are the snap-on type and can be retrofitted.



Cat. No.	KU1.V	KU2.V	VKA1.V	VKA2.V
<b>Electrical Rating</b>	10A/1/2HP/125-250V AC	10A/1/2HP/125-250V AC	10A/1/2HP/125-250V AC	10A/1/2HP/125-250V AC
<b>No. of contacts</b>	1n.o./1n.c.	2n.o./2n.c.	1n.o./1n.c.	2n.o./2n.c.
<b>For Use With</b>	KU models	KU models	VKA models	VKA models

### FUSE HOLDER

This fuseholder can be retrofitted with the KU340N. Therefore design changes can be incorporated with ease to allow a fusible disconnect.



Shown with extended handle switch.



Cat. No.	KV 10x38	KV 10x38 CC
<b>Electrical Rating</b>	30A/600V AC	30A/600V AC
<b>Fuse Type</b>	10x38, Midget	Class CC
<b>For Use With</b>	KU340N	KU340N

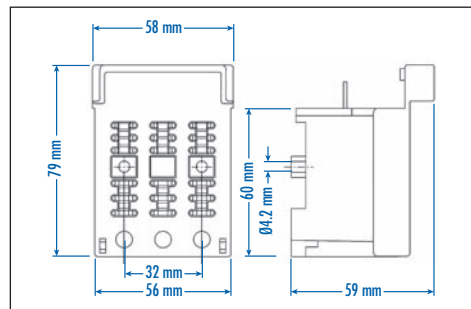

Dimensions (to convert to inches multiply by 0.03937)

# MANUAL DISCONNECT SWITCH

## Direct Handle Accessories

### DIRECT HANDLES

Improved design with metal shaft. Use for all your "inside the panel" applications.



<b>Cat. No.</b>	K/KU3P	K/KU3P Y/R	K/KU4P	K/KU4P Y/R	K/VKA3-4P	K/VKA3-4P Y/R
<b>Color</b>	Black	Yellow/Red	Black	Yellow/Red	Black	Yellow/Red
<b>For use with</b>	KU models (3P)	KU models (3P)	KU models (4P)	KU models (4P)	VKA models (3/4P)	VKA models (3/4P)

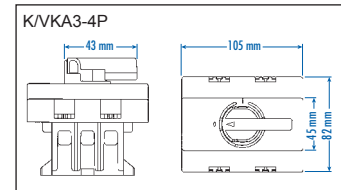
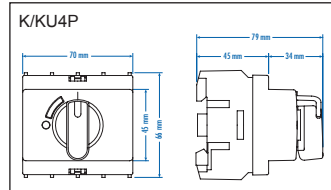
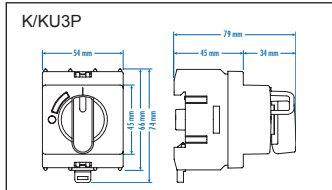

### DOOR MOUNTING KITS

Designed for fast and easy assembly.



Shown with switch and display plate. (sold separately)

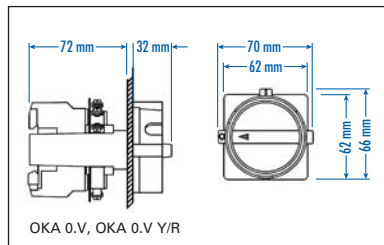

<b>Cat. No.</b>	OKA 0.V	OKA 0.V Y/R
<b>Environmental Rating</b>	IP65	IP65
<b>Color</b>	Black	Yellow/Red
<b>For use with</b>	KU models (3P)	KU models (3P)

### MOUNTING ALTERNATIVES

#### - ALUMINUM DIN RAIL

Panel mount option for small Disconnect Switches.



<b>Cat. No.</b>	RKA 3P	RKA 4P
<b>For Use With</b>	KU325/40/63N	KU425/40/63N



Shown with switch and display plate. (sold separately)

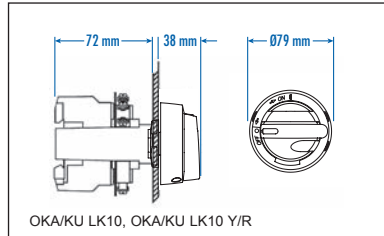

<b>Cat. No.</b>	OKA/KU LK10	OKA/KU LK10 Y/R
<b>Environmental Rating</b>	NEMA Type 4X, IP66	NEMA Type 4X, IP66
<b>Color</b>	Black	Yellow/Red
<b>For use with</b>	KU models (3P)	KU models (3P)

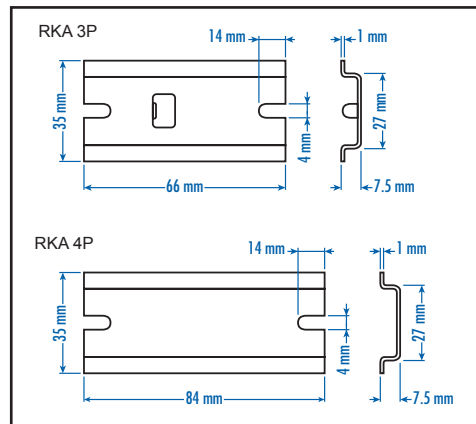

Shown with switch. (sold separately)

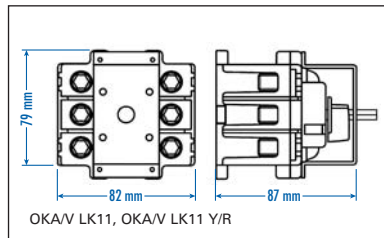

<b>Cat. No.</b>	OKA/V LK11	OKA/V LK11 Y/R
<b>Environmental Rating</b>	NEMA Type 4X, IP67	NEMA Type 4X, IP67
<b>Color</b>	Black	Yellow/Red
<b>For use with</b>	VKA models (3P)	VKA models (3P)

### NOTE:

In the rare case that your mounting hardware (screws) for DIN Rail interfere with the enforcement studs in the back of the Motor Disconnect Switch please use smaller (2M3 or equivalent) flathead screws or change your DIN Rail to the 15mm high version.

**Dimensions** (to convert to inches multiply by 0.03937)

## Stainless Steel Enclosed Motor Disconnect Switch



The enclosures are designed for use where chemical solutions are used for wash-down maintenance as in food processing and breweries. They are also suitable for use in salt air and spray environments both shore-side and shipboard. The Stainless Steel construction of the enclosure is extremely resistant to corrosion and is IP66 rated.



### Catalog Number

Black Handle

Yellow/ Red Handle

No. of Poles	
General Purpose Current	
Maximum Voltage	
Motor FLA @ 480V AC	
Motor FLA @ 600V AC	

KER325UL  
KER325UL Y/R

3*
25A
600V AC
17.5A
11A

KER340UL  
KER340UL Y/R

3*
40A
600V AC
28A
18A

### Horsepower Rating /HP

110-120V AC
200V AC
208V AC
220-240V AC
265V AC
277V AC
380-415V AC
440-480V AC
550-600V AC

1 Phase	3 Phase
1	2
2	5
2	5
3	7.5
3	7.5
3	7.5
5	10
7.5	15
5	10

1 Phase	3 Phase
2	3
3	7.5
3	7.5
5	10
5	10
5	10
7.5	15
10	20
7.5	15

### Short Circuit Withstand Rating at 600 V with Max. Fuse Size/Class:

K5
RK5
RK1
J

10kA
50A
50A
80A
80A

10kA
50A
50A
80A
80A

### Terminal Size Acceptability

(Cu Conductors only, 75°C)

Terminal Torque
Environmental Rating
Enclosure Type Used

14-8AWG

14-8AWG

16 lb. in.

NEMA Type 4X

H23

16 lb. in.

NEMA Type 4X

H23

### Dimensions

(to convert to inches multiply by 0.03937)

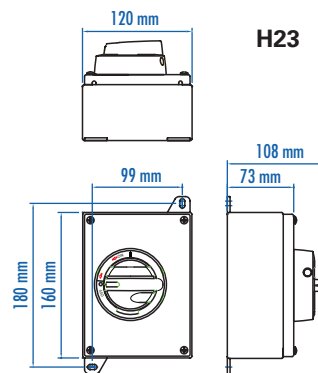

Weight
--------

1.35kg (2.98 lb.)

1.35kg (2.98 lb.)

### Suitable Accessories

Auxiliary Contacts
--------------------

KU1.V, KU2.V

KU1.V, KU2.V

\*Also available in 4 pole models.

# MANUAL DISCONNECT SWITCH

## Stainless Steel Enclosed Motor Disconnect Switch



KER360UL  
KER360UL Y/R

3*
60A
600V AC
34A
27A

1 Phase	3 Phase
3	5
5	10
5	10
5	10
5	10
7.5	10
10	20
15	25
15	25

10kA
60A
60A (80A @480V AC)
100A
100A

12-4AWG

16 lb. in.
NEMA Type 4X
H32

KER380UL  
KER380UL Y/R

3*
80A
600V AC
—
47A

1 Phase	3 Phase
3	7.5
7.5	10
7.5	15
7.5	15
10	20
10	20
15	25
20	30
25	40

10kA
150A
150A
—
200A

4-1/0AWG

50 lb. in.
NEMA Type 4X
H32

KER3100UL  
KER3100UL Y/R

3*
100A
600V AC
—
54A

1 Phase	3 Phase
3	7.5
7.5	15
7.5	15
10	20
10	20
10	20
15	30
20	40
30	50

10kA
150A
150A
—
200A

4-1/0AWG

50 lb. in.
NEMA Type 4X
H32

KER3125UL  
KER3125UL Y/R

3*
125A
600V AC
—
68A

1 Phase	3 Phase
5	10
10	20
10	20
15	25
15	25
15	30
20	40
30	50
30	60

10kA
150A
150A
—
200A

4-1/0AWG

50 lb. in.
NEMA Type 4X
H32

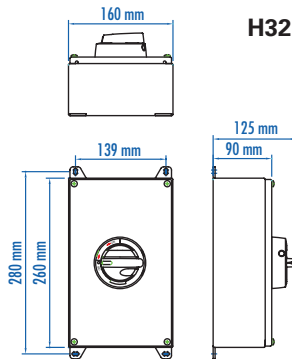

2.66kg (5.87 lb.)

2.66kg (5.87 lb.)

2.66kg (5.87 lb.)

2.66kg (5.87 lb.)

KU1.V, KU2.V

VKA1.V, VKA2.V

VKA1.V, VKA2.V

VKA1.V, VKA2.V



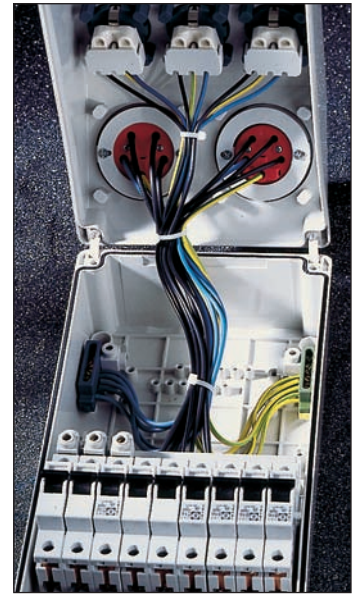

### Combination Outlets Save 50 — 75% in Time and Material Costs

Walther Electric introduces a custom-built power distribution system, made up of multiple variations of receptacles, that we call "Combination Outlets".

Combination outlets combine multiple receptacles or an assortment of receptacles into one compact enclosure. By combining numerous receptacles within one electrical enclosure, multiple conduit runs with individual branch circuit wiring can be eliminated; as a result, significantly reducing material costs. These combination outlets are supplied complete with all internal wiring and in most cases only require one connection to the incoming electrical supply conduit.

The Walther combination outlet system utilizes standard NEMA wiring devices, IEC309 pin and sleeve connectors, or practically any type of connection that meets your specific requirements (European "Schuko", French, United Kingdom, Australian, Italian, Swiss, Israeli, Danish, Japanese, etc.).

Because of the compact size of these combinations, installation of multiple receptacles in tight or limited space is normally not a problem. In fact, many of the enclosures are designed to fit within the web of an 8" column allowing the use of columns as a mounting location.

Best of all, overload protection is typically provided with built-in circuit breakers within the enclosure, which are easily accessible by opening the see-through cover. This cover can be secured by a choice of methods ranging from a simple thumbscrew to lockout protection for greater safety and compliance with OSHA Lockout/Tagout regulations. The Walther combination outlet system also utilizes fuses, RCD's, GFCI breakers or practically any type of overload protection that meets your specific requirements.

The high impact thermoplastic and solid rubber enclosures, while abuse and corrosion resistant, are also non conductive, which enhances the safety of the product (consult technical service for stainless steel enclosures).

Each combination is checked in accordance with EN 60 439-1; 1994 table 7 and test certificates are provided with each unit. This test data is saved and can be retrieved at any time.

Walther Electric welcomes the opportunity to manufacture custom combinations of receptacles and inlets built to your specific needs and requirements. The examples shown in this section represent only a small fraction of the possible combinations available. Our application engineers are at your service to help plan and construct combination units according to your specific requirements. Simply call 1-800-WALTHER.

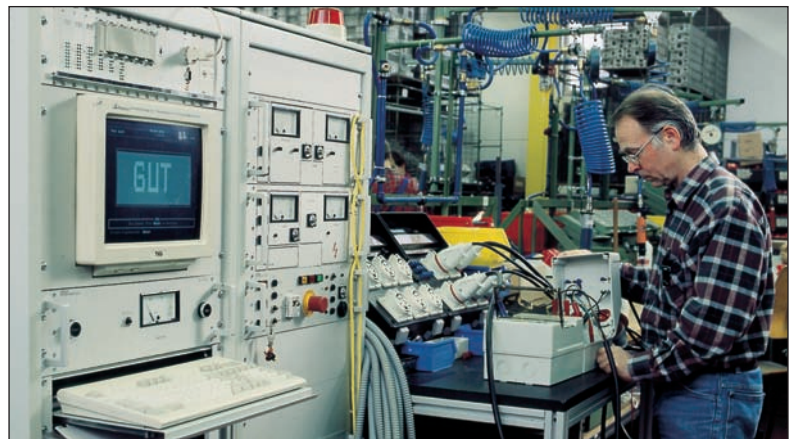



COMBINATION OUTLETS



PEDESTALS AND FRAMES



HANGING COMBINATIONS



Walther Electric welcomes the opportunity to manufacture custom combinations of receptacles and inlets built to your specific needs and requirements. The examples shown in this section represent only a small fraction of the possible combinations available. Our application engineers are at your service to help plan and construct combination units according to your specific requirements. Simply call 1-800-WALTHER.



Part No: 64929DD  
 Enclosure: Solid Rubber P/N 6499901, UL Type 3R  
 Input: 50 Amp, 120/240V Inlet  
 Output: Three (3) 20 Amp, GFCI Duplex Receptacles, 125V, NEMA 5-20R with cover  
 One (1) 50 Amp Receptacle 125/250V with cover



Overload Protection: Three (3) 20 Amp, UL Type C, 1-Pole Circuit Breakers  
 One (1) 50 Amp, UL Type C, 2-Pole Circuit Breakers  
 Dimensions: 10.6" x 10.8" x 12.2" H  
 Including Handle (270mm x 275mm x 310mm H)  
 Weight: 18 lbs.  
 Application: Shipyards, Industrial, Construction, Etc.



Part No: 64829AR  
 Enclosure: Solid Rubber P/N 6489901, UL Type 1  
 (With 4 External Mounting Brackets & Handle)  
 Input: 50 Amp, 120/240V Inlet  
 Output: Six (6) 20 Amp, GFCI Duplex Receptacles, 125V, NEMA 5-20R with cover  
 One (1) 50 Amp Receptacle 125/250V with cover  
 Overload Protection: Two (2) 20 Amp, UL Type C, 1-Pole Circuit Breakers  
 Dimensions: 16.5" x 13.6" x 8.4" D  
 Not Including Handle (420mm x 345mm x 213mm D)  
 Weight: 33 lbs.  
 Application: Shipyards





Plug (Input)	(Output)		Overload Protection
	No.	Receptacles	
NEMA L21-30P 30A 3ØY120/208 VAC	3	NEMA 5-20R 20A 125VAC	3 MCB's 1 Pole 20A>>C<<



Plug (Input)	(Output)		Overload Protection
	No.	Receptacles	
Stage Pin 60 AMP	3	NEMA 5-20R 20A 125VAC	3 MCB's 1 Pole 20A>>C<<



Plug (Input)	(Output)		Overload Protection
	No.	Receptacles	
Customer Supplied Cable	2	NEMA 5-20R 20A 125VAC-Quad Plex	2 MCB's 1 Pole 20A>>C<<



Plug (Input)	(Output)		Overload Protection
	No.	Receptacles	
IEC309-1 and 309-2 60A 3ØY120/208 VAC	9	NEMA 5-20R 20A 125VAC	9 MCB's 1 Pole 20A>>C<<



Plug (Input)	(Output)		Overload Protection
	No.	Receptacles	
	IEC309-1 and 309-2 5 Wire, 32 Amp	3	
	1	IEC309-1 and 309-2 5 Wire, 16 Amp	1 MCB's 3 Pole 16A>>C<<
	3	Schuko Socket Outlets	3 MCB's 1 Pole 16A>>B<<



Plug (Input)	(Output)		Overload Protection
	No.	Receptacles	
Cam Connectors 400 Amp	15	NEMA 5-20R 20A 125VAC	15 MCB's 1 Pole 20A>>C<<



Plug (Input)	(Output)		Overload Protection
	No.	Receptacles	
	IEC309-1 and 309-2 5 Wire, 63 Amp	2	
	2	IEC309-1 and 309-2 5 Wire, 16 Amp	2 MCB's 3 Pole 16A>>C<<
	8	Schuko Socket Outlets	4 MCB's 1 Pole 16A>>B<<

Walther Electric welcomes the opportunity to manufacture custom combinations of receptacles and inlets built to your specific needs and requirements. The examples shown in this section represent only a small fraction of the possible combinations available. Our application engineers are at your service to help plan and construct combination units according to your specific requirements. Simply call 1-800-WALTHER.



Part No: 6WE2000  
 Enclosure: Solid Rubber, Type 6419901, UL Type 3R  
 Input: NEMA L21-30P with 2-meter supply cable  
 Output: Three (3), NEMA 5-20R, RED / BLACK / BLUE, each circuit with an indicator light  
 Power Feed- Through Cable: NEMA L21-30R with 2-meter supply cable  
 Overload  
 Protection: Three (3), MCB, 20-Amp, 1-Phase  
 Dimensions: L17.56" x B4.53" x H4.34"  
 (446mm x 115mm x 110mm)  
 Weight: 6 lbs.  
 Application: Entertainment: Convention Halls



Part No: 64829AW  
 Enclosure: Solid Rubber P/N 6489901, UL Type 1  
 Input: Hardwire With Main On/Off Switch  
 Output: Four (4) CEETyp, Female Receptacles, 60/63-Amp, 5-Wire (3P+N+G), Walther no. 569509  
 One (1) 50 Amp Receptacle, 125/250V, CS6369 with cover  
 Overload Four (4) 63 Amp, UL Type C,  
 Protection: 3-Pole Circuit Breakers  
 One (1) 50 Amp, UL Type C,  
 2-Pole Circuit Breaker  
 Dimensions: 31.1" x 13.6" x 4.5"  
 (H=790mm x L=345mm x W=115mm)  
 Weight: 60 lbs.  
 Application: GENSET PDU



Part No: 64917AL  
 Enclosure: Solid Rubber P/N 6499901, UL Type 3R  
 Input: 60 Amp Male Plug, 3 Pole, 4 Wire Grounding, 3 Phase 480 VAC IEC309-1 and 309-2  
 6.5' (2 Meters) Supply Cable  
 Output: Three (3) Amp, Receptacles, 3 Pole, 4 Wire Grounding, 3 Phase 480 VAC, IEC309-1 and 309-2  
 Overload Three (3) 32 Amp, UL Type C,  
 Protection: 3-Pole Circuit Breakers  
 Dimensions: 10.6" x 10.8" x 12.2" H  
 Including Handle (270mm x 275mm x 310mm H)  
 Weight: 26 lbs.  
 Application: Shipyards



Part No: 64829AW  
 Enclosure: Solid Rubber Type 648 (x3), Wall Mount, UL Type 1  
 Input: Hardwire  
 Output: Three (3) Rows, CAM-LOK, E16, Female, (3P+G), with protective covers.  
 One (1) 50 Amp Receptacle, 125/250V, CS6369, with Weatherproof Plate.  
 Two (2), CEETyp, 60-Amp, Female Receptacles, 5W (3P+N+G), 569509.  
 One (1), 50-Amp, 2P open terminal block for future expansion with breaker.  
 Overload Three (3) 40 Amp, UL Type C, 3-Pole Circuit Breakers (CAMs)  
 Protection: Two (2) 50 Amp, UL Type C, 2-Pole Circuit Breaker  
 Two (2) 60 Amp, UL Type C, 3-Pole Circuit Breaker (CEETyp)  
 Dimensions: 14.6" x 40.7" x 4.5"  
 (H=370mm x L=1035mm x W=115mm)  
 Weight: 60 lbs.  
 Application: GENSET PDU



Part No: 64829AY  
 Enclosure: Two (2) Solid Rubber P/N 6489901  
 UL Type 1  
 Input: CEETyp, IEC309-1/-2, 100-Amp, Male Inlet, 3-Phase Y120/208V, 5-Wire, Walther no. 679521  
 With 100-Amp Main On/Off Switch  
 Output: Six (6) NEMA 5-20R, 20-Amp, Female Receptacles, 3-Wire (1P+N+G) with covers  
 Five (5) CAM-LOK Connectors, E16, (Black, Red, Blue, White, Green) with covers  
 One (1) NEMA 18-50R, 50-Amp, Female Receptacle, 4-Wire (3P+G) with cover  
 Overload Six (6) 20 Amp, UL Type C,  
 Protection: 1-Pole Circuit Breakers  
 One (1) 50 Amp, UL Type C,  
 3-Pole Circuit Breaker  
 Dimensions: 17" x 14" x 14"  
 (H x L x W)  
 Weight: 62 lbs.  
 Application: GENSET PDU

**OTHER INDUSTRIES AND APPLICATIONS**

- Amusement Parks and Attractions

---

- Convention Centers, Trade Fairs and Exhibitions

---

- Fairgrounds, Flea Markets and Bazaars

---

- Indoor/Outdoor Concerts and Performances

---

- Military

---

- Temporary Lighting Systems

---

- Wherever portable and/or temporary power distribution is required



**PORTABLE  
POWER**



**NEW!**



**Safety**  
**Durability**  
**Versatility**

